



A | S | E | R | I | E | S

A-Series Multi-function display

User reference manual

A50, A50D, A57D, A70 and A70D models

Raymarine[®]

Trademarks and registered trademarks

Autohelm, HSB, RayTech Navigator, Sail Pilot, SeaTalk and Sportpilot are UK registered trademarks of Raymarine UK Limited.

Pathfinder and Raymarine are UK registered trademarks of Raymarine Holdings Limited. 45STV, 60STV, AST, Autoadapt, Auto GST, AutoSeastate, AutoTrim, Bidata, G-Series, HDFI, LifeTag, Marine Intelligence, Maxiview, On Board, Raychart, Raynav, Raypilot, RayTalk, Raystar, ST40, ST60+, Seaclutter, Smart Route, Tridata and Waypoint Navigation are trademarks of Raymarine UK Limited.

All other product names are trademarks or registered trademarks of their respective owners.

© **Raymarine UK Ltd. 2008**

Contents

Important information10

Warnings and Cautions	10
Electronic charts	11

Chapter 2:Using the display14

Introduction	15
System overview	15
Core System	15
Extended System	16
Applications	17
First time use	18
Controls	20
Operation	21
Powering the display ON/OFF	21
Cursor	21
Panning and zooming	21
Display lighting and color	22
Additional screen information	23
Setup menus	25
Dialog boxes	25
Displaying applications	26
Selecting a page set	26
Selecting an application page	26

Split screen pages	27
Emergencies and warnings	28
Man overboard	28
Alarms	28

Chapter 3:Waypoints 30

Introducing waypoints	31
Using Waypoints	32
The waypoint toolbar	32
Creating waypoints	32
Navigating to waypoints	33
View / edit waypoint details	34
Moving waypoints	35
Erasing a waypoint	36
Waypoint groups	36

Chapter 4:The chart application 38

Chart safety and requirements	39
Safety	39
The chart	40
Your position	41
Moving around the chart	41
Autoscale	41
Navigating to a specific point	42

Creating a route	43
Following a route.....	45
Editing routes	46
Timed routes.....	47
Course deviation indicator.....	48
Using tracks	49
Editing and deleting tracks.....	49
Measuring distance, range and bearing.....	50
Chart presentation.....	52
Chart layers	52
Vectors and arrows.....	52
Chart mode and orientation	53
Chart detail	54
Journey planning.....	55
Tide and current information.....	55
Bathymetric information	57
Details of objects and features	57
Details of ports, port and business services	58
Pilot book information	58
Panoramic and aerial photographs.....	59
Chart setup.....	60
Datum	61
Chart offset and cartography setup	61
Chart scale.....	63
Alarms.....	63

Chapter 5:3D chart application	64
Safety and system requirements.....	65
Safety.....	65
Requirements.....	65
3D chart operation.....	65
The controls.....	66
Active and Planning modes.....	66
Changing the view.....	67
Making the view clearer.....	68
Using the standard and 3D charts together.....	69
3D view locator.....	69
Chart synchronization.....	70
Aerial photography overlay.....	71
Setting up the 3D chart.....	71
Chapter 6:Fishfinder application	72
The fishfinder screen.....	73
How the fishfinder works	73
Interpreting the Fishfinder image.....	74
Bottom indications.....	74
Factors influencing the readout.....	74
Fishfinder Pre-set operation	75
Preset display modes	75
Changing the depth range.....	79
Range shift	79

Presentation options	80	Tropical storm data	93
Gain and power	80	Lightning	93
Power setting.....	81	Surface observation stations.....	93
Dual / Single frequency view	81	City forecasts	93
Measuring depth and distance	82	Wind.....	94
Adjusting the scroll mode and speed	83	Waves.....	94
Placing waypoints	84	Surface pressure.....	95
Fishfinder alarms	84	Viewing data for a specific position.....	95
Fishfinder Setup Menu.....	85	Animated weather graphics	95
Screen settings.....	85	Viewing weather reports	96
Transducer settings.....	87	Watchbox warnings.....	96
Chapter 7:Sirius weather (US only).....	88	Displaying marine watchboxes	97
System requirements.....	89	Troubleshooting	97
Using Sirius Weather	89	Weather application setup	97
Creating a weather page	89	Chapter 8:Sirius Audio (US only)	100
The weather display	89	Using Sirius Radio	101
Specifying meteorological elements.....	90	Tuning to a channel	101
Moving around the weather map.....	90	Browsing channels.....	102
Placing waypoints.....	90	Scanning channels.....	102
Weather symbols.....	90	Hiding or showing channels and categories	102
Precipitation (NOWRad).....	91	Presets.....	103
Storm Cast	91	Parental locking	104
Sea surface temperature (SST).....	92	Entering passwords	104
Canadian radar.....	92	Favourite song alerts	104
Tracking storms.....	92		

Chapter 9:Navtex.....	106
Setting up Navtex.....	107
Selecting message alert categories	107
The Navtex message window	107
Managing Navtex messages.....	108
Sorting the message list	108
Chapter 10:AIS	110
Background information	111
Classes of AIS data	111
Setting up AIS	112
Using AIS	112
AIS status icons	112
AIS Layer	113
The AIS screen	113
AIS Target symbols	114
Viewing AIS information.....	114
Safe zones	114
Safe zone alarm.....	114
AIS display options.....	115
Displaying AIS vectors.....	115
Displaying safety-critical AIS data	115
AIS list.....	116
Full AIS data	116
AIS Options softkey	116

Messages and alarms	117
Safety messages.....	117
AIS alarms.....	117
Active alarm list	117
Chapter 11:Data and Engine monitors	120
System requirements	121
Engine requirements	121
Data monitoring requirements	121
Data application.....	121
Selecting the data application page	121
Preset data panels	122
Engine monitor	122
Setting up the engine monitor	122
Preset engine monitor panels.....	123
Temperature and fuel units	123
Engine monitor alarms	123
Customizing data panels	124
Chapter 12:System Setup and Customizing	126
Page sets	127
Databar and Compass	127
Compass Setup.....	128
GPS status	128
Satellite differential system.....	129

COG/SOG filter	129
System-wide settings	130
System Setup menu	130
Alarm Setup Menu.....	132

Chapter 13: Storing data and Chart / CF cards..136

Card use and information	137
Using the card slot.....	138
Storing and retrieving data.....	139
Sending and receiving data with a computer	140
Password protection	140
Password confirmation	140
Disabled data/functions	141
Enabling and disabling password protection	141

Chapter 14: Maintenance and troubleshooting..142

Safety.....	143
Routine checks	143
Cleaning	143
Resetting the system	144
Settings reset	144
Settings and data reset	144
Troubleshooting	145
Installation and display	145
Chart application	146
Weather application.....	146

Contacting Raymarine	147
Using the website.....	147
In the US	147
In Europe	148
Worldwide	148
Contacting Navionics	148
Navionics Italy.....	148
Navionics US	148
Navionics Australia	148
Navionics UK	149
Contacting Sirius.....	149
Navionics license agreement	150
Sirius weather	151

Important information

Warnings and Cautions



WARNING: Navigation aid

This product is intended to serve only as an aid to navigation. Use of specific features such as AIS overlay, and various cartographic aids are meant only to aid safety and decision-making. These features cannot be relied upon as complete or accurate as their use and availability may vary locally. It is your responsibility to use caution, sound judgement, official government charts, notices to mariners and proper navigational skill when using this or any other electronic device.



WARNING: Product installation

This equipment must be installed in accordance with the Raymarine instructions provided. Failure to do so could result in poor product performance, personal injury, and/or damage to your boat.



WARNING: High voltages

The display unit contains high voltages. DO NOT remove the display unit covers or attempt to service the equipment.



WARNING: Service and Maintenance

This product contains no user serviceable components. Please refer all maintenance and repair to authorized Raymarine dealers. Unauthorized repair may affect your warranty.

CAUTION: CompactFlash cards

When installing CompactFlash cards ensure that the card is fitted the correct way around. DO NOT try to force the card into position as this may result in irreparable damage to the card. Removing the CompactFlash card while information is being written to or read from it may cause damage to the card and loss of all data. DO NOT use a metallic instrument such as a screwdriver or pliers to remove a card, as doing this can cause irreparable damage.

CAUTION: Water ingress

To prevent the ingress of water and consequent damage to the display, ensure that the chart card door is firmly closed. This can be confirmed by an audible click.

CAUTION: Sun covers

To provide protection against the damaging effects of ultra violet (UV) light, use the sun covers when equipment is not in use.

CAUTION: Cleaning

DO NOT use acid, ammonia based or abrasive products.
DO NOT use commercial high pressure washing (jet wash) equipment.

Electronic charts

Electronic charts are an aid to navigation designed to facilitate the use of authorized government charts, not to replace them. Only official government charts and notices to mariners contain the current information needed for safe navigation. The Captain is responsible for their prudent use. The A-Series Multifunction Display and its charts do not therefore exclude the user from carrying the required official charts and documents.

Raymarine does not warrant that this product is error-free or that it is compatible with products manufactured by any person or entity other than Raymarine.

This product uses digital chart data, and electronic information from the Global positioning System (GPS) which may contain errors. Raymarine does not warrant the accuracy of such information and you are advised that errors in such information may cause the product to malfunction. Raymarine is not responsible for damages or injuries caused by you use or inability to use the product, by the interaction of the product with products manufactured by others, or by errors in chart data or information utilized by the product and supplied by third parties.

Multi-media chart cards

The A-Series Multifunction Display is compatible with Navionics chart data. You, you can insert Navionics chart cards into the CompactFlash card slot on the unit.

If your A-Series is pre-loaded with cartography, chart cards can provide alternative cartography regions and features.

When a chart card is present, the A-Series will automatically use the most recent cartography for the display.

To check the current availability of Navionics chart card types and the latest feature sets, visit www.navionics.com or www.navionics.it

To obtain Navionics card, contact your local dealer or visit the Navionics website.

Alternatively anywhere in North America call Navionics toll-free on:
1-800-848-5896.

Outside of North America, contact your local dealer or Navionics SpA on:

Phone: (+39) 0584961696

Fax: (+39) 0584 961309

When archiving data, Raymarine recommends the use of SanDisk CF memory cards. Other brands of CF memory card may not work in your unit.

EMC conformance

All Raymarine equipment and accessories are designed to the best industry standards for use in the leisure marine market.

The design and manufacture of Raymarine equipment and accessories conform to the appropriate Electromagnetic Compatibility (EMC) standards, but correct installation is required to ensure that performance is not compromised.

Declaration of conformity

Raymarine Ltd. declare that the A-Series Multifunction Displays are in compliance with the essential requirements of EMC directive 2004/108/EC.

The original Declaration of Conformity certificate may be viewed on the relevant product page at www.raymarine.com

Product disposal



The Waste Electrical and Electronic Equipment (WEEE) Directive requires the recycling of waste electrical and electronic equipment. Whilst the WEEE Directive does not apply to some Raymarine products, we support its policy and ask you to be aware of how to dispose of this product.

The crossed out wheeled bin symbol, illustrated above, and found on our products, signifies that this product should not be disposed of in general waste or landfill.

Please contact your local dealer, national distributor or Raymarine Technical Services for information on product disposal.

Warranty

To register your Raymarine A-Series Multifunction Display ownership, please take a few minutes to fill out the warranty registration card found in the box, or visit www.raymarine.com and register online.

It is important that you register your product to receive full warranty benefits. Your unit package includes a barcode label indicating the serial number of the unit. You should stick this label to the warranty registration card.

About this manual

This handbook contains important information on the operation and maintenance of all of these models and variants which are intended for use on leisure marine boats and workboats not covered by International Maritime Organization (IMO) and Safety of Life at Sea (SOLAS) Carriage Regulations.

Technical accuracy

To the best of our knowledge, the information in this handbook was correct as it went to press. However, Raymarine cannot accept liability for any inaccuracies or omissions it may contain. In addition, our policy of continuous product improvement may change specifications without notice. As a result, Raymarine cannot accept liability for any differences between the product and the handbook.

Chapter 2: Using the display

This chapter gives details of the general operation of the A-Series display.

2

Chapter contents

- [2.1 Introduction on page 15](#)
- [2.2 System overview on page 15](#)
- [2.3 Applications on page 17](#)
- [2.4 First time use on page 18](#)
- [2.5 Controls on page 20](#)
- [2.6 Operation on page 21](#)
- [2.7 Additional screen information on page 23](#)
- [2.8 Displaying applications on page 26](#)
- [2.9 Emergencies and warnings on page 28](#)

2.1 Introduction

The A-Series Multifunction display combines advanced chart plotting and high definition digital fishfinder technology within a compact and powerful navigation system.

Your A-Series Multifunction Display comes equipped with a VGA (640 x 280 pixel) TFT 256 color sunlight viewable display and an internal high sensitivity GPS module.



A-Series models

- A50 - 5" display, GPS Chartplotter
- A50D - 5" display, GPS Chartplotter/Fishfinder combination
- A57D - 5.7" display, GPS Chartplotter/Fishfinder combination
- A70 - 6.4" display, GPS Chartplotter
- A70D - 6.4" display, GPS Chartplotter/Fishfinder combination

2.2 System overview

Core System

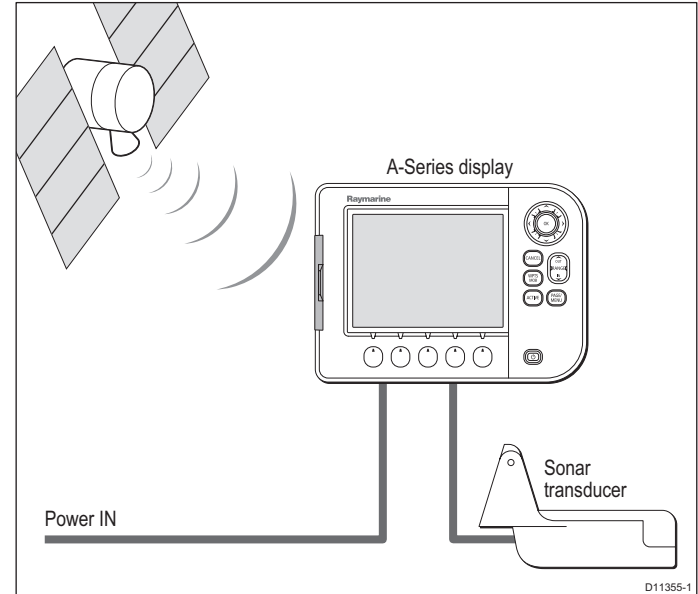

Extended System

Your A-Series may connect to other equipment, for example to share data.

Example extended system

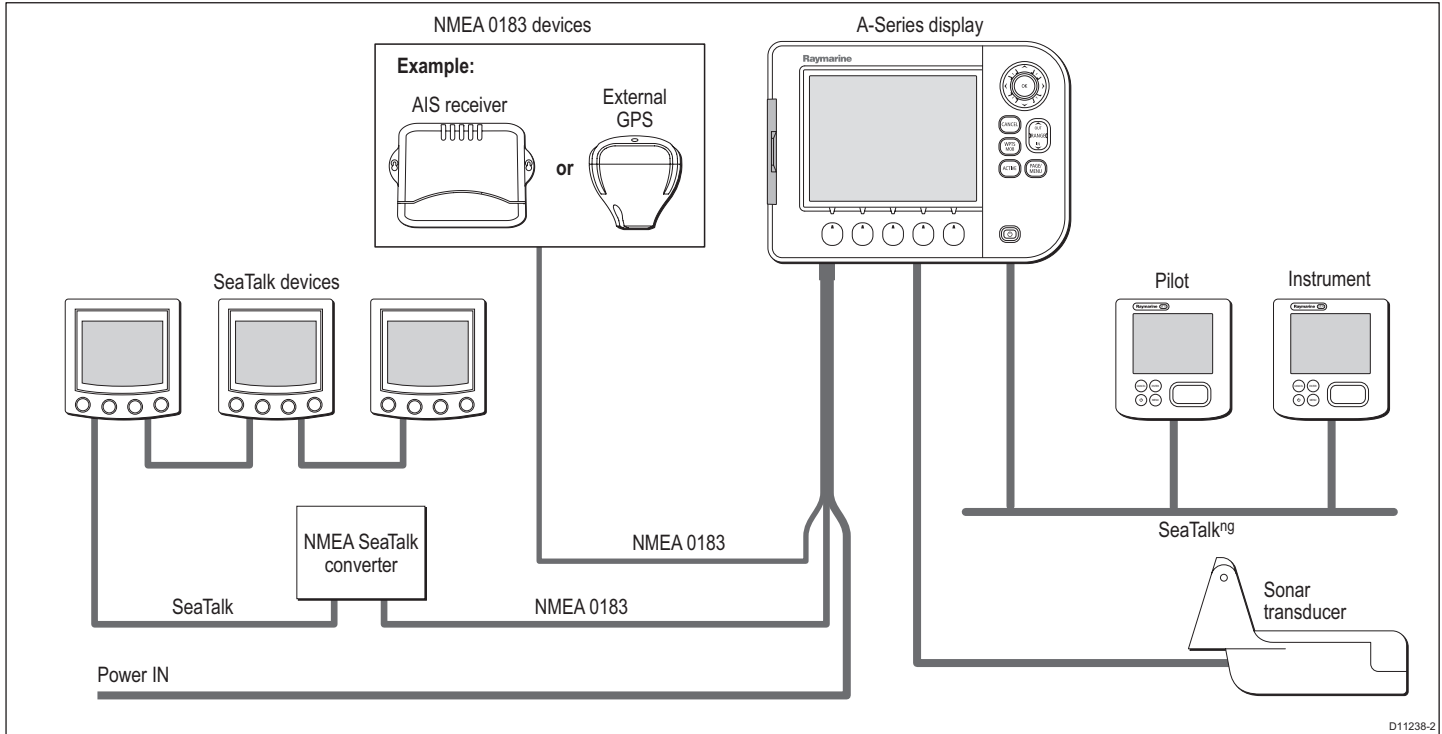

D11238-2

Protocols

The A-Series is compatible with:

- NMEA 0183 (e.g. for AIS, or external GPS connection)

- SeaTalk^{ng}

2.3 Applications

The A-Series features are provided within a number of applications. Some applications are limited to certain models.

Chartplotter



- Locate where you are
- Interpret your surroundings.
- Monitor where you are going.
- Record where you have been.
- Navigate to a specified position (waypoint).
- Build and navigate routes.
- View details of nearby features & services.
- View details of boats equipped with AIS.
- Measure distances and bearings.

Fishfinder (D Models only)

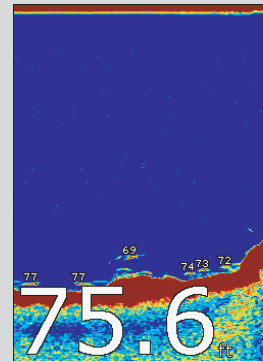

- See where the fish are.
- Identify underwater objects.
- View seabed structure.
- View sea depth and temperature data.
- Mark points of interest, like fishing spots or wrecks

Course Deviation Indicator (CDI)



- View real-time display of your vessel on a 'rolling road' in 3D perspective.
- Give details of any correction required to steer your vessel along a given course.
- View data about the distance and time to go until you reach a specified point.

Data

Ves Pos 25°45'.940N 080°09'.718W	GOTO CURSOR 220°T 1.28nm	TTG --h--m--s	VWG Wpt -.-kt
Depth 78.8ft	Cog Sog 286°T 0.0kt	Heading 293°T	Speed 0.0kt
Set Drift 355°T 0.0kt	XTE 0.00nm Steer >	Trip 0.00nm	Local Time 01:42:12

- View data generated by the system or by instruments available on NMEA 0183, NMEA 2000 or SeaTalk¹⁹.

3d chart

Requires upgraded cartography (chart card).



- Display a 3D view of land, sea & features.
- Locate where you are.
- Interpret your surroundings.
- Monitor where you are going.
- Go to an existing waypoint.
- Navigate a route.
- Synchronize with the 2D chart.
- Identify fishing spots.

D18200-1

2.4 First time use

When you first use your A-Series Display after it has been installed we recommend that you carry out the following:

Turn on the display

To Power ON:



Press and hold the **POWER** key until the screen shows the Raymarine logo.

Select a page set.

When you first turn the display on you will be prompted to select a page set from those available.

Note: You can change the required page set at any time. See [Displaying applications on page 26](#).

To Select a page set at first time Power on:

1. Use the trackpad **Up/Down** keys to select the required Page Set.

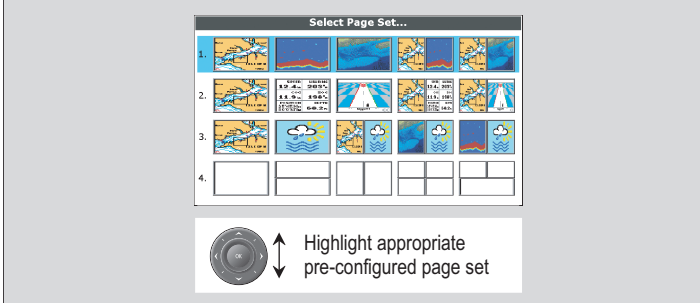

Select Page Set...

1. [Page Set 1] [Page Set 2] [Page Set 3] [Page Set 4] [Page Set 5]

2. [Page Set 6] [Page Set 7] [Page Set 8] [Page Set 9] [Page Set 10]

3. [Page Set 11] [Page Set 12] [Page Set 13] [Page Set 14] [Page Set 15]

4. [] [] [] [] []

↑ Highlight appropriate pre-configured page set ↓

2. Press **OK** when complete.

Simulator

Your A-Series display includes a simulator mode that enables you to practice operating the unit without data from a GPS antenna or transducer unit.

Note: The simulator will NOT display any real-data, including any safety messages (e.g. those received from AIS).

To turn the simulator ON or OFF:

1. Press and hold the **PAGE/MENU** button to display the setup menu.
2. Use the trackpad **up / down** keys to select **System Setup**.
3. Press trackpad **right** to select the **System Setup** options.
4. Select the Simulator option
5. Select **ON** or **OFF** as required.
6. Press the **OK** key to return back through the menus.

2.5 Controls

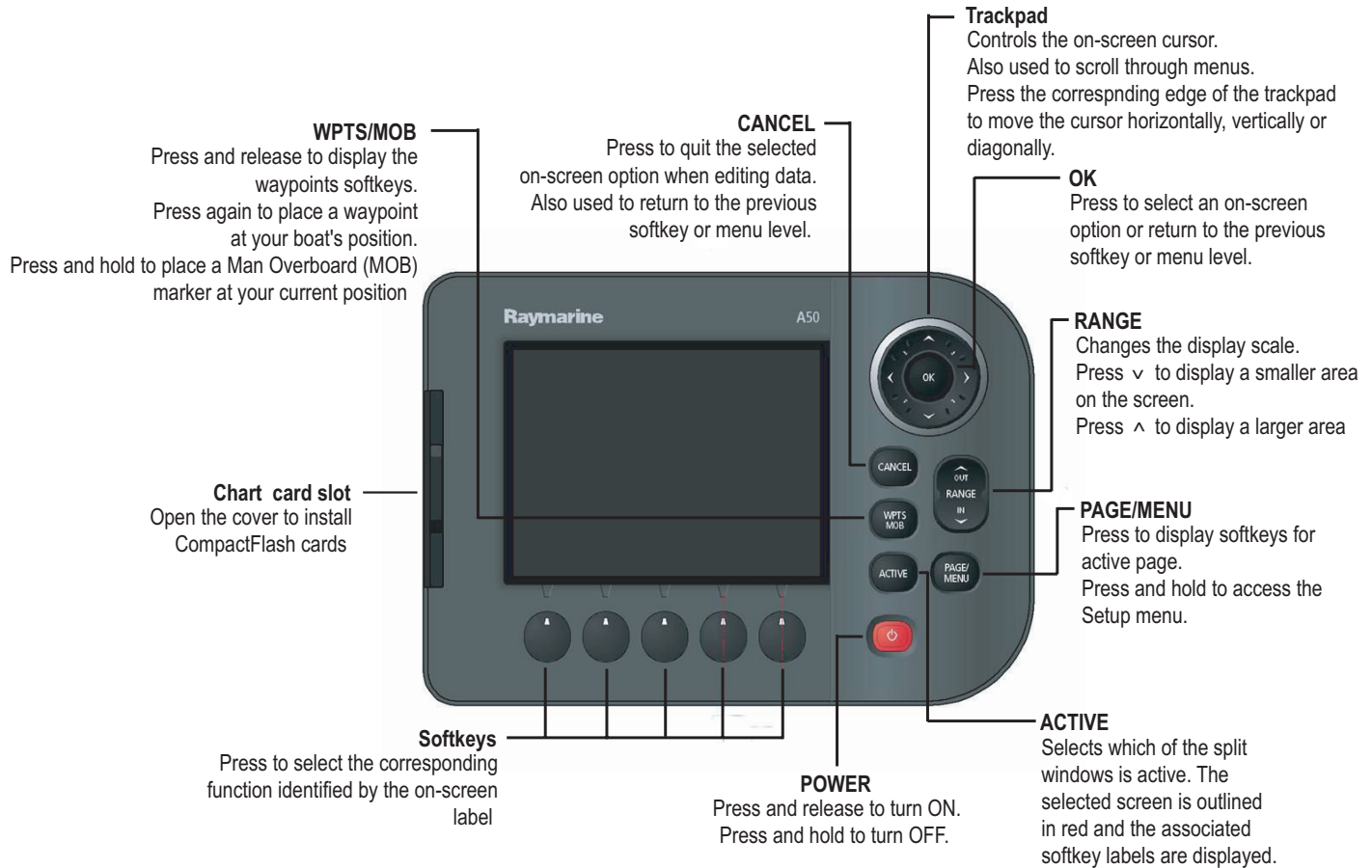

2.6 Operation

Powering the display ON/OFF



To Power ON:

Press and hold the **POWER** key until the screen shows the Raymarine logo. The unit starts up in the last used display configuration.

To Power OFF:

Press and hold the **POWER** key until the power down countdown reaches zero. The unit is powered OFF. Releasing the POWER key before the countdown is complete cancels the power off sequence.

Cursor

When you are using chart and fishfinder applications, the cursor is used to move around the screen.

To move the cursor:



Press the trackpad in the direction you want the cursor to move.

Cursor appearance

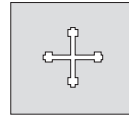

The cursor appears on the screen as a white cross.

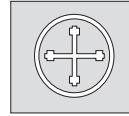

If the cursor has not been moved for a short period of time, it changes to a circle with a cross in it, to make it easier to locate on screen.



The cursor is context-sensitive; when it is placed over an object, e.g. a waypoint or chart feature, it changes color and a label or information associated with the object is shown. Placing the cursor over certain items will also cause the softkeys to change, enabling you to access related operations.

Panning and zooming

In the appropriate chart or fishfinder application windows, you can pan and zoom the view to show a different geographic area (pan) or change the scale at which an area is displayed (zoom).

To Pan the view



Use the trackpad to move the cursor to the edge of the screen. The view automatically moves in the selected direction to bring a different area into view.

To Zoom in or out



Use the **RANGE** button to change the scale of the viewable area. Press 'IN' to see a smaller area of the screen in more detail (large scale). Press 'OUT' to see a greater area of the chart (small scale).

The level of cartographic detail available at different scales varies depending upon the chart card used. Some charts provide more detail at smaller scales than others.

If you select a chart scale that does not provide cartographic detail for the chosen area, the chart will use the most detailed level available for the surrounding area and stretch it to fit the selected scale. This means that you will never have blank or hatched areas on the screen. However minor misalignment of objects may occur where they cross the chart boundaries.

Display lighting and color

Your display unit has two distinct color palettes, for day or night operation. You can also manually adjust the backlight level.

Day/Night operation

To select the day/night mode of operation:

1. Press the **Power** key to display the palette select softkey and brightness level.
2. Press the appropriate softkey to select between Day and Night palettes.

Note: The display saves the current palette when the unit is powered off. A display set to NIGHT may be difficult to see in bright sunlight.

Backlight level

To adjust the backlight level:

1. Press the **Power** key to display the backlight level bar.
2. Use the **left / right** trackpad keys to adjust the backlight level.
3. Press **OK** to accept the setting and exit the backlight adjustment.

2.7 Additional screen information

Status bar

- Gives information specific to each application.
- Cannot be edited or moved.

Data bar

- Gives information associated with your boat or the environment.
- Customisable content.
- Vertical or horizontal format.
- Display or hide.
- Normal or large size.

Status icons

Confirm status of
Sounder, GPS, AIS and
Autopilot

Data base lists

- Contain information you have added to the display's memory e.g. waypoints.
- Highlight an entry using trackpad or rotary control to display related information.
- Editable using soft keys.

Pop-up messages

- Alert you to a situation e.g. alarm, function not available.
- Not editable.
- May require a response e.g. press ACKNOWLEDGE to silence alarms.

Dialog boxes

Enable data to be edited or entered into a store/list e.g. editing a waypoint.

The screenshot displays a marine navigation interface. At the top, there are three bars: a Status bar with 'Csr 25°45'.346N 000 °T', a Data bar with 'Pos 080°07'.962W 7 ft', and another Data bar with 'Yes 25°45'.350N Pos 080°07'.961W'. To the right of these bars are status icons for FIX, AIS, and PILOT. Below the bars is a map showing 'BISCA BAY' and 'OBSTN FISH HAVEN'. A 'Waypoint List' dialog box is open, showing a list of waypoints and details for 'Waypoint 1'. An 'Edit Waypoint' dialog box is also open, showing fields for Name, Group, Position, Rng/Brg, and Comment. A red 'AIS ALARM' pop-up message is displayed over the 'Edit Waypoint' dialog, with the text 'Dangerous Target'. At the bottom of the screen, there is an 'ACKNOWLEDGE' button.

Toolbars and softkeys

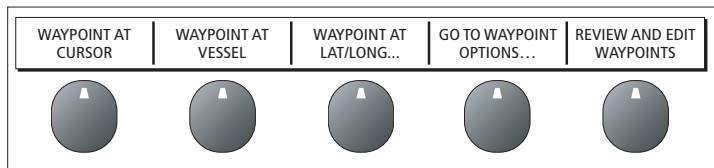

A toolbar is a set of softkey labels which appear along the bottom of an application page or window.

Pressing a softkey can cause a new toolbar to appear, call up an options window or menu list, or trigger an action such as setting your boat on a track to a selected waypoint. Some softkeys have pop-ups or sliders associated with them, where you make setting adjustments using the trackpad.

It is useful to think of toolbars as being arranged in tiers. To access some functions, you need to go to a second or third tier. If you accidentally press the wrong softkey, you can go back up a tier by pressing the **CANCEL** button.

If there are additional tiers below a softkey, the softkey label ends with an ellipsis (...). For example, pressing **GOTO....** on the navigation toolbar opens the GOTO toolbar, enabling access to further options.

Note: When instructions in this handbook refer to softkey labels, the ellipsis is not included.

Compass bar

The compass bar gives you a continuous readout centred on your current heading or course over ground (COG). Arrows at either end of the bar indicate current steer direction.

When displayed, it replaces the databar and is always positioned at the top of the screen.

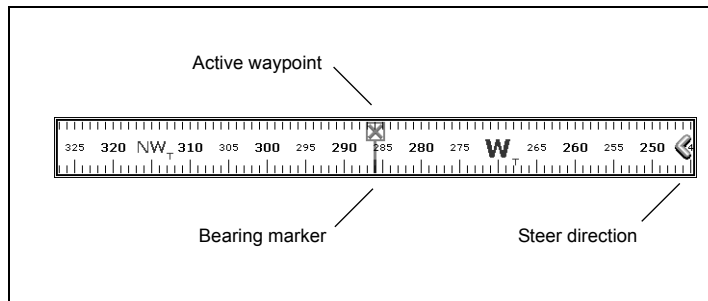

- In **heading** mode, the bearing marker is **RED**.
- In **COG** mode, the bearing marker is **GREEN**.
- When you use the compass bar with an **active waypoint**, the bearing marker is **BLUE** and the active waypoint symbol indicates the bearing to your waypoint.

You turn the compass bar on and off from the data toolbar.

To turn the compass bar on and off

1. Press and hold the **PAGE/MENU** button to display the system setup menu.
2. Use the trackpad **up/down** to highlight the **Databar setup** option.
3. Press the trackpad **right** to open Databar setup menu
4. Set the **Type and Position** option to **Top Compass**.
5. Press **OK** to save your selection.

Note: When the compass bar is displayed the transducer icons remain visible in the top-right section of the screen.

Setup menus

Menus are provided for you to make system or application changes.

To use the Setup menus

1. Press and hold the **PAGE/MENU** button to open the Setup menu.
2. Use the Trackpad **up / down** to scroll through the available items.
The list of items may be longer than the screen; scroll down past the end of the list to display hidden items.
3. Use the Trackpad **right** to open a sub-menu or a list of options.
4. Press the **OK** button to select the required setting or **CANCEL** to go back to the previous screen.

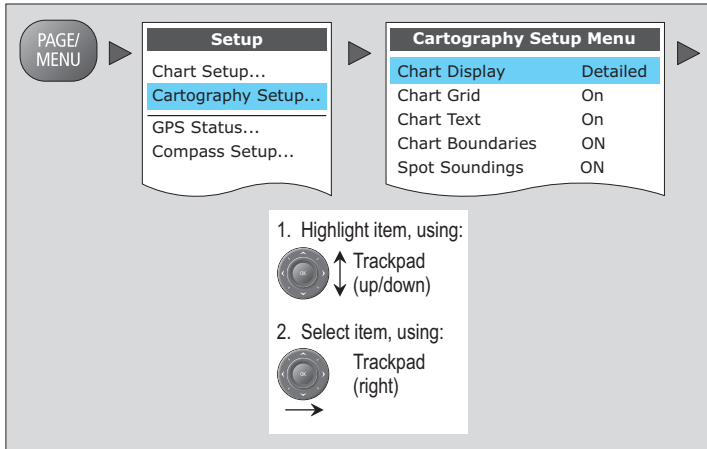

Application setup menus are context sensitive: if you are in the chart application, for example, the chart setup menu is available.

See also

For full details of the setup menus and available settings refer to [System Setup and Customizing on page 126](#).

Dialog boxes

Dialog boxes are provided for you to edit or enter data. They appear automatically at appropriate points. For example if you edit a list of waypoints, a dialog box appears for you to enter or change a waypoint name.

To enter data into a dialog box

1. Select the appropriate field.

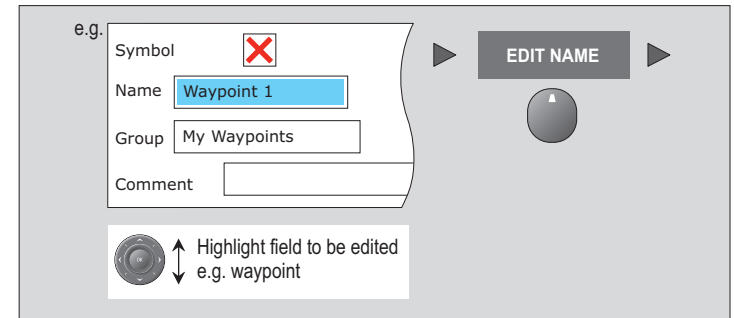

2. Enter the data. Press OK to save the changes.

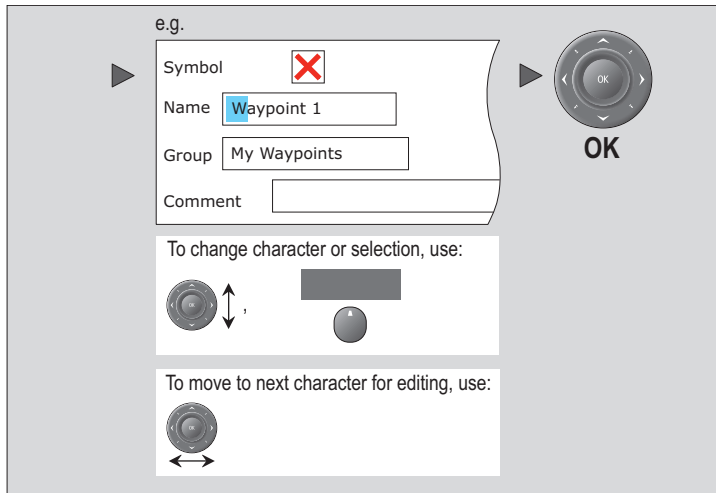

You can enter character text in upper- or lower-case but the system is not case sensitive: it considers 'WAYPOINT 1' to be the same as 'Waypoint 1'.

To use special or accented characters, turn on the Extended Character Set in the System Setup Menu (see [System Setup menu on page 130](#)).

2.8 Displaying applications

The various applications that make up your A-Series system are arranged in groups called page sets.

Selecting a page set

To select a page set:

1. Press and hold the **PAGE/MENU** button to display the setup menu
2. Choose the **Select Page Set** option.

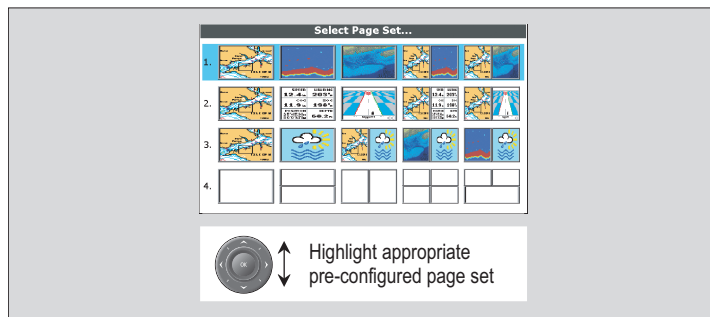

Selecting an application page

Once you have selected the appropriate page set, as detailed above, choose the application page that you want to use.

To view an application page:

1. Press **PAGE/MENU** to show the available pages in the toolbar.

2. Either select the application page you want from the toolbar or toggle between the applications configured in the page set by pressing **PAGE/MENU**.
3. Press **OK** or **CANCEL**.

Split screen pages

When the selected page has more than one application, the window that is currently active has a red border.

When selecting between active windows, the toolbar changes accordingly.

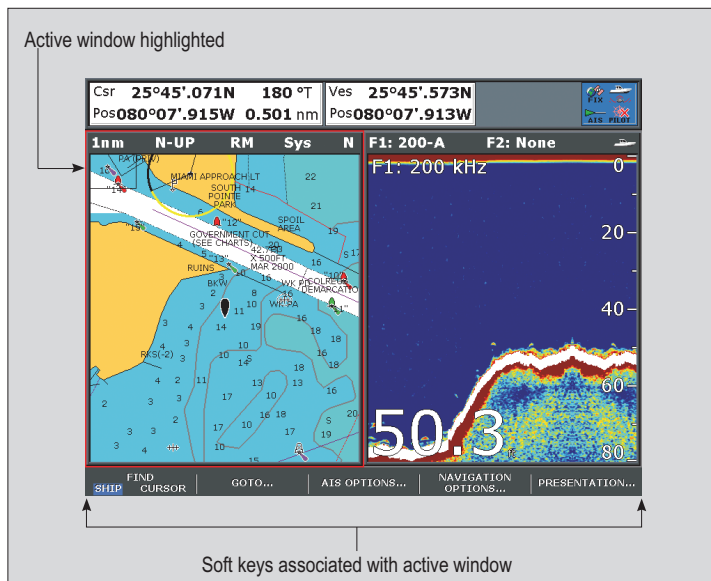

To change the active window

1. Press **ACTIVE** to toggle active status between windows (the red border moves to highlight the active window).

To toggle between split and single window views

1. In a multiple-window view, press and hold the **ACTIVE** button to display the active window at full-screen.
2. Press **ACTIVE** once more to return to multiple-window view.

See also

- You can customize the page sets to contain your own preferred applications and split-screen layouts. See [Page sets on page 127](#).

2.9 Emergencies and warnings

You can use your A-Series display to mark the position of a man overboard (MOB) or to sound an alarm when a particular situation occurs, e.g. when a depth limit is reached or a specified period of time has elapsed.

Man overboard

If you lose a person or object overboard and need to return to the spot, activate the Man Overboard (MOB) function immediately. The MOB function is available at all times, whatever application is running on the A-Series display.

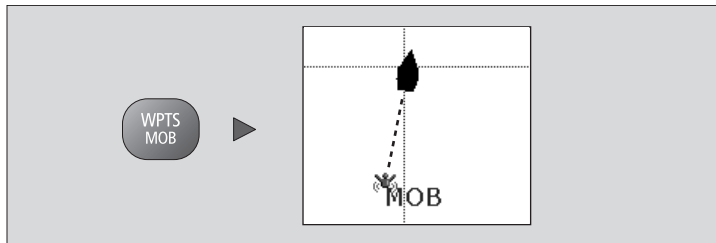

To activate the Man Overboard function

1. Press and hold the **WPTS/MOB** key for three seconds.

Placing a MOB marker initiates the following actions:

- **MOB waypoint** placed at your boat's current position.
- **Alarm** sounds in morse code (--- letter O) and is repeated every 30 seconds.
- **Positional information** including bearing, range and position are displayed in the databar.

- **Navigation functions** are suspended and no new GOTO or route functions are selectable.
- **Motion mode** on the chart application is changed to autorange to show the largest possible scale of chart that will include both the MOB and your boat.
- **Current position** to MOB position is represented on-screen by a dotted line.

Note: To obtain an MOB position, your A-Series display must have a GPS fix.

To cancel an MOB alarm:

1. Press and hold the **WPTS/MOB** button for four seconds.

Once the MOB alarm is cleared:

- the chart application motion mode is reset.
- the databar mode is reset.
- GOTO and route functions are restored.

Alarms

Alarms are used to alert you of a hazard or particular situation. When an alarm sounds, a message box appears on-screen to explain the reason for the alarm.

Cancelling an alarm

There are two types of alarms; system and external.

- **System alarms** are triggered by A-Series applications, i.e the chart or fishfinder. When you cancel a system alarm, the A-Series cancels the alarm and makes appropriate changes to the application that triggered it. For example, if the chart application sounds an arrival alarm, navigation to the next waypoint in the route starts when you cancel the alarm.
- **External alarms** are triggered by equipment that is connected to your A-Series system, but which are not part of the system, e.g. AIS. When you cancel an external alarm, the alarm stops but no further action is taken.

Both types of alarm are cancelled in the same way.

To cancel an alarm:

1. Press the **ACKNOWLEDGE** softkey.

See also

You can configure the alarm types and settings for your display. See [Alarm Setup Menu on page 132](#).

Chapter 3: Waypoints

This chapter introduces waypoints and explains how to use them for navigation with your A-Series Multifunction Display.

Chapter contents

- [3.1 Introducing waypoints on page 31](#)
- [3.2 Using Waypoints on page 32](#)
- [3.3 Waypoint groups on page 36](#)

3.1 Introducing waypoints

A waypoint is a position marked on a chart or fishfinder screen as a reference point or as a place to go to and can be used as a building block when creating routes. Waypoints are represented on screen by a symbol and their details stored in a waypoint list.

Waypoints can be created in any application and displayed on the chart and fishfinder windows.

Chart waypoints

On a 2D chart all waypoints are shown.

The active waypoint (i.e the one to which you are heading) has a box placed around the symbol to highlight it.

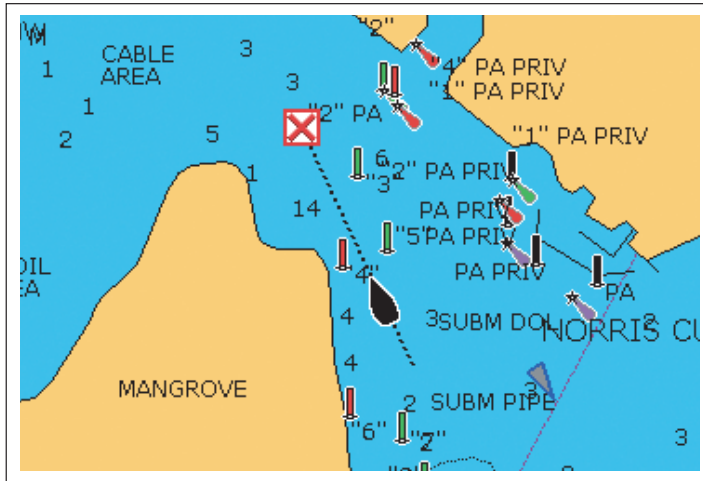

Fishfinder waypoints

On a fishfinder screen the waypoint appears as a vertical line labelled WPT. This representation cannot be changed.

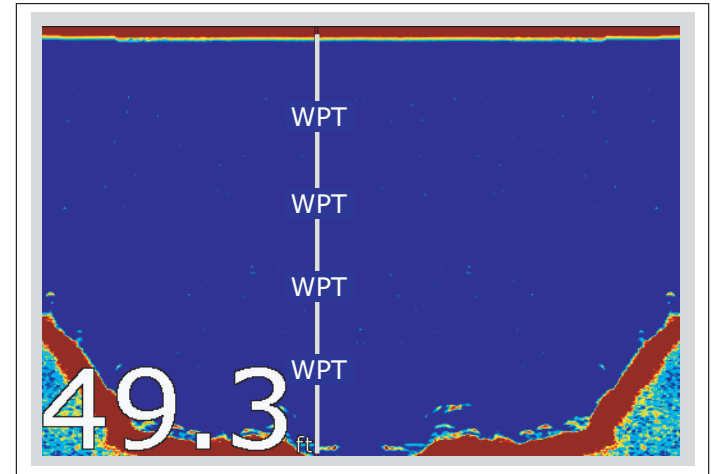

3D chart and CDI waypoints

On a 3D chart or Course Deviation Indicator (CDI) only the active waypoint is shown.

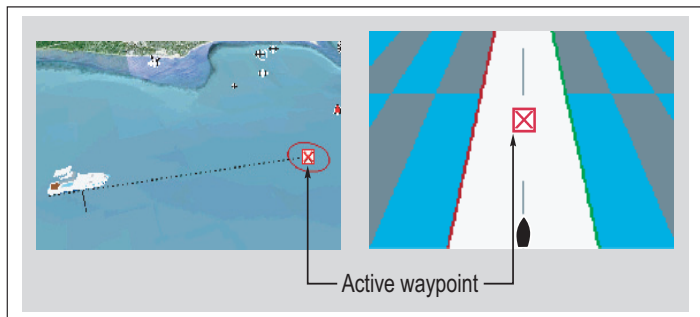

3.2 Using Waypoints

This section details the creation, navigation and editing of waypoints.

The waypoint toolbar

You can use the waypoint toolbar to create, edit and navigate to waypoints.

To display the waypoints toolbar

1. Press the **WPTS/MOB** button:

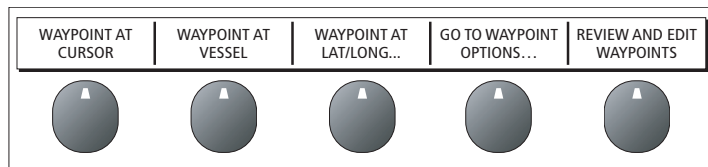

Creating waypoints

You can place a waypoint at:

- the cursor.
- your boat's position.
- a point specified by latitude and longitude or Loran TD coordinates.

To set up your system for Loran TD coordinates refer to [System Setup menu on page 130](#).

To place a waypoint at the cursor

1. Press the **WPTS/MOB** button to display the waypoints toolbar.

2. Using the trackpad move the cursor to the position where you want the waypoint.
3. Press the **WAYPOINT AT CURSOR** softkey.
4. Press **OK**.

To place a waypoint at your boat's position:

1. Press the **WPTS/MOB** button.
2. Press the **WAYPOINT AT VESSEL** softkey.
3. Press **OK**.

Note: If the system cannot determine your position, a warning is displayed and the waypoint cannot be placed.

To place a waypoint using coordinates:

1. Press the **WPTS/MOB** button.
2. Press the **WAYPOINT AT LAT/LON** softkey.
3. Set the position for the new waypoint.
4. Press **OK**.

Navigating to waypoints

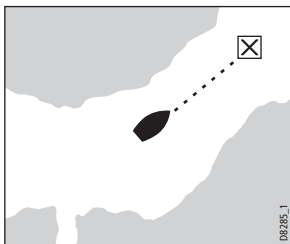

This section explains how to start and stop navigating to a waypoint. When you navigate to a waypoint, the data is sent to your autopilot. The waypoint to which you are navigating is the **active waypoint**.

Note: Autopilots must be compatible and connected to the A-Series display as shown in the installation guide.

For detailed information on navigating with waypoints, see [The chart application on page 38](#).

To navigate to a waypoint

1. Highlight the waypoint.
2. Press the **GOTO WAYPOINT** softkey.

or

1. Press either the **WPTS/MOB** button or **GOTO** softkey.
2. Press the **GOTO WAYPOINT OPTIONS** softkey.
3. Select the appropriate waypoint from the list.
4. Press **GOTO WAYPOINT**.

To stop navigating to a waypoint

1. Highlight the waypoint.
2. Press the **STOP GOTO** softkey.

or

1. Press the **WPTS/MOB** button.
2. Press the **GOTO WAYPOINT OPTIONS** softkey.
3. Press the **STOP GOTO** softkey.

View / edit waypoint details

You can view and edit the details of any waypoint that has been created and stored.

Waypoint List	
Name:	Group: My Waypoints
Waypoint 1	Position: 50°53'.826N 001°10'.963W
Waypoint 2	Rng/Brg: 284° 4.315nm
Waypoint 3	
	Temperature: ---.-°F
	Depth: ---.-ft
	Date: 05/11/2003
	Time: 14:59:11

To view waypoint information

1. Highlight a waypoint with the cursor.
2. Press the **VIEW AND EDIT DETAILS** softkey.

or

1. Press the **WPTS/MOB** button.
2. Press the **REVIEW AND EDIT WAYPOINTS** softkey.

Note: Use the second method to view details for an active waypoint.

Editing waypoint details

When you create a waypoint, the system automatically assigns it a name, symbol and group. You can change these details and add comments if required. This is particularly useful if you are managing large groups of waypoints.

The default waypoint symbol is - **X**.

You can select different waypoint symbols to differentiate between groups of waypoints (fishing or diving locations, for example). When a waypoint is active (being navigated to) it is highlighted by a red box placed around the symbol.

You can choose any of the following symbols to show your waypoints:

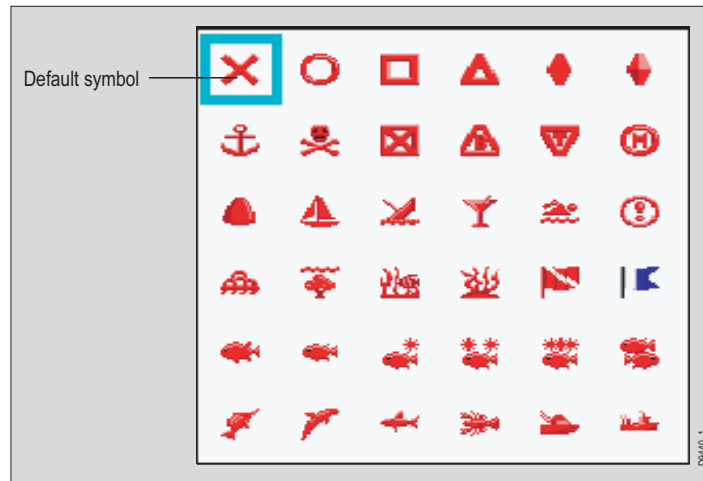

To edit waypoint details:

1. Press the **WPTS/MOB** button.

2. Press the **REVIEW AND EDIT WAYPOINTS** softkey
3. Use the trackpad to select the waypoint to be edited.
4. Press the **VIEW AND EDIT DETAILS** softkey.
5. Make any changes you require.
6. Press **OK** to save your changes.
7. Press **CANCEL** to return to normal operation.

Sorting the waypoint list

You can sort the waypoint list to make it easier to manage. This is particularly useful if you have a large number of waypoints.

To sort the waypoint list:

1. Press the **WPTS/MOB** button.
2. Press the **REVIEW AND EDIT WAYPOINTS** softkey
3. Press the **SORT LIST** softkey.
4. Press the **SELECT SORT OPTION** softkey.
5. Select a sort method from the list.
6. Press **OK**. The waypoint list is sorted into the selected option.

Moving waypoints



CAUTION: Moving waypoints

If you move a waypoint that is used in a route, the new position will be updated within the route. Make sure that this does not present a navigation hazard.

You can move the position of any waypoint, except an active one. There are two methods of moving a waypoint, either by dragging it into a new position using the cursor, or, changing its co-ordinates within the waypoint list.

To move a waypoint using the cursor:

1. Use the trackpad to place the cursor over the waypoint to be moved.
2. Press the **MOVE WAYPOINT** softkey.
3. Use the trackpad to move the cursor and waypoint to the required position.
4. Press the **PLACE WAYPOINT** softkey.

To move a waypoint using the waypoint list:

1. Press the **WPTS/MOB** button.
2. Press the **REVIEW AND EDIT WAYPOINTS** softkey.
3. Edit the coordinates as required.
4. Press **OK** to save the new details.

Erasing a waypoint

You can erase any waypoint, *except* the active waypoint or one that is part of a saved route. If you try to erase a waypoint from a hidden route, a warning message will be displayed.

To erase an on-screen waypoint using the cursor:

1. Use the trackpad to place the cursor over the required waypoint.
2. Press the **ERASE WAYPOINT** softkey.
3. Press **OK** to confirm.

To erase a waypoint using the waypoint list:

1. Press the **WPTS/MOB** button.
2. Press the **REVIEW AND EDIT WAYPOINTS** softkey.
3. Use the trackpad to select the waypoint from the list.
4. Press the **ERASE WAYPOINT** softkey.
5. Press **OK** to confirm the deletion. The waypoint is deleted.

To erase all waypoints

1. Press and hold the **PAGE/MENU** button.
2. Select **SYSTEM SETUP**.
3. Select **ARCHIVE AND TRANSFER** softkey.
4. Press the **ERASE FROM SYSTEM** softkey.
5. Highlight **WPT** on the **SELECT LIST** softkey.
6. Select **ERASE ALL WAYPOINTS**.
7. Confirm the deletion.

3.3 Waypoint groups

All new waypoints are automatically placed in a group called 'My Waypoints'. To make waypoints easier to manage, you can organize them into different groups. When fishing, for example, you can choose to see only the waypoints in a fishing group that includes all of your good fishing sites.

Note: A waypoint can only belong to one group.

To open the waypoint group list:

1. Press the **WPTS/MOB** button.
2. Press the **REVIEW AND EDIT WAYPOINTS** softkey.
3. Press the **WAYPOINTS GROUP** softkey. The waypoints group list appears.

You can now:

- Make a new waypoint group.
- Move waypoints between groups.
- Rename groups.
- Erase groups.

To make a new waypoint group

1. Open the waypoint group list.
2. Press the **MAKE NEW GROUP** softkey.
3. If you want to give the group a name other than the default, press **EDIT GROUP NAME** and set the name.
4. Press **OK**.

To move waypoints between groups

1. Open the waypoint group list.
2. Press the **MOVE BETWEEN GROUPS** softkey.

3. Press **SELECT GROUP A** and select the group to move the waypoint from.
4. Press **SELECT GROUP B** and select the group to move the waypoint to.
5. Highlight the waypoint you want to move.
6. Press **MOVE WAYPOINT FROM A TO B**.
7. Press **OK** when done.

To rename a group

1. Open the waypoint group list.
2. Highlight the group you want to rename.
3. Press the **RENAME GROUP** softkey.
4. Press the **EDIT GROUP NAME** softkey.
5. Enter the new name.
6. Press **OK**.

Deleting waypoint groups

When you delete a waypoint group, the group name and all the associated waypoints are erased from the system.

If a group contains one or more waypoints that you want to keep, move these waypoints out of the group as detailed on [page 36](#), before deleting the waypoint group.

You can erase any waypoint group, *except* the following:

- the 'My Waypoints' group.
- a group containing an active waypoint.
- a group that contains waypoints that are part of a stored route.

To erase a waypoint group:

1. Open the waypoint group list.
2. Select the group you want to erase.

3. Press the **ERASE GROUP** softkey.
4. Press **OK** to confirm the deletion.

Chapter 4: The chart application

The chart application of the A-Series Multifunction Display provides navigation, hazard awareness and planning features.

Using the chart application you can establish your position, navigate using waypoints and routes, record your progress and measure distances and bearings:

Chapter contents

- [4.1 Chart safety and requirements on page 39](#)
- [4.2 The chart on page 40](#)
- [4.3 Navigating to a specific point on page 42](#)
- [4.4 Creating a route on page 43](#)
- [4.5 Following a route on page 45](#)
- [4.6 Editing routes on page 46](#)
- [4.7 Course deviation indicator on page 48](#)
- [4.9 Measuring distance, range and bearing on page 50](#)
- [4.10 Chart presentation on page 52](#)
- [4.11 Chart detail on page 54](#)
- [4.12 Journey planning on page 55](#)
- [4.13 Chart setup on page 60](#)

See also...

- [The chart application on page 38](#)
- [Waypoints on page 30](#)

4.1 Chart safety and requirements

Safety



WARNING: Navigation aid

This product is intended to serve only as an aid to navigation. Use of specific features such as AIS overlay, and various cartographic aids are meant only to aid safety and decision-making. These features cannot be relied upon as complete or accurate as their use and availability may vary locally. It is your responsibility to use caution, sound judgement, official government charts, notices to mariners and proper navigational skill when using this or any other electronic device.

Always check that your route is safe. Use the **RANGE** button to zoom in and check for hazards that may not be visible on a larger scale view.

Until you are familiar with interpreting the chart display, take every opportunity to compare what's shown on the chart display with your actual surroundings. Practice harbor and coastal navigation during daylight hours and in clear weather conditions. You can also use the simulator mode to gain experience in using your display unit.

Before you use the chart application make sure you have read and understand [Chapter 3:Waypoints](#).

4.2 The chart

A typical chart view is shown below:

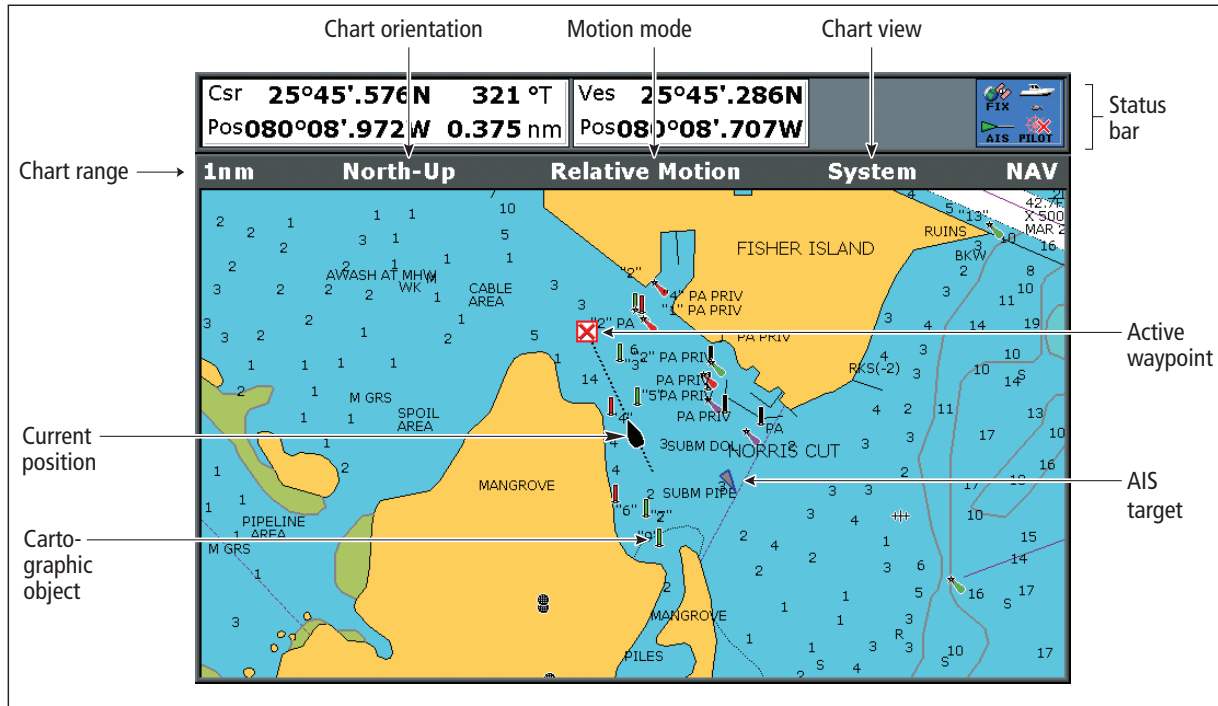

Chart cards

When a chart card is present, the A-Series will automatically use the most recent cartography for the display.

Your position



Your current position is represented by a boat symbol. Your position is also displayed in the data bar under VES POS.

A solid circle on the chart indicates that neither heading nor Course Over Ground (COG) data is available.

If your position is outside the area of chart currently shown in the chart window, the vessel symbol will not be visible. You can tell the system to locate your vessel and centre the chart display about it.

To locate your vessel

1. Press the **FIND** softkey to switch between the **SHIP** and Cursor location.

Moving around the chart



To move around the chart and display the area required at an appropriate scale, use the track pad and range in/out buttons.

Note: Remember that the cartographic detail available on the chart will vary according to the chart and chart scale. Some charts provide details at smaller scales than others.

Autoscale

A feature of the chart application is 'autoscale'. If you select a chart scale that does not have cartographic detail in some areas, the chart will automatically use the most detailed level available for the surrounding area and stretch it to fit the selected scale. This means that you will never have blank or hatched areas on the screen. However, there may be some misalignment of objects which cross the chart boundary in this area.

4.3 Navigating to a specific point

This is the simplest way of using the chart application for navigation. A specific point can be either the cursor position or a waypoint contained in the waypoint list.

Example Drg

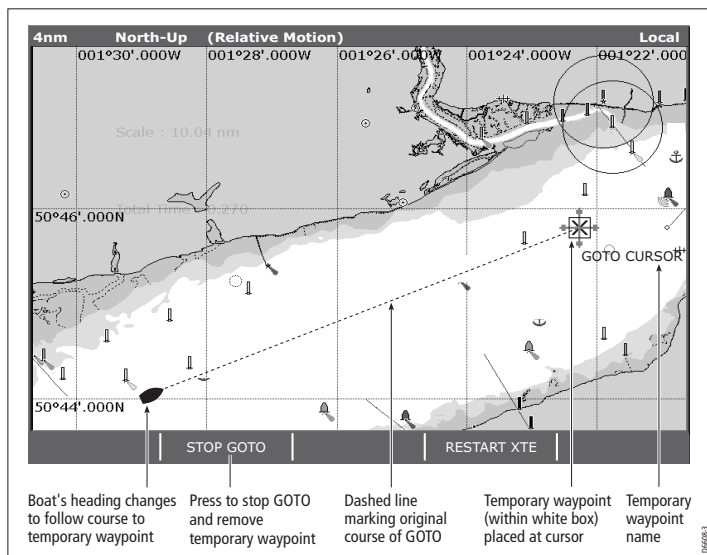

To navigate to the cursor position:

1. Use the trackpad to move the cursor to the required position.
2. Press the **GOTO** softkey.

3. Press the **GOTO CURSOR** softkey.

A temporary waypoint is placed at the cursor position and data sent to the autopilot (if attached as part of the system).

When the waypoint is reached it is automatically erased from the chart.

To navigate to a waypoint:

1. Move the cursor over the required waypoint.
2. Press the **GOTO WAYPOINT** softkey.

or

1. Press the **GOTO** softkey.
2. Press the **GOTO WAYPOINT OPTIONS** softkey to open the waypoint list.
3. Select the waypoint you want to navigate to.
4. Press the **GOTO WAYPOINT** softkey.

To stop navigating to a waypoint

1. Press the **STOP GOTO** softkey.

Maintaining a view of your navigation

With auto range mode the chart automatically adjusts the visible range to maintain both your boat and the target waypoint on screen, using the largest scale possible.

To select auto range mode:

1. Press the **PRESENTATION** softkey
2. Press the **CHART MODE AND ORIENTATION** softkey
3. Press the **MOTION MODE** softkey and select **AR** option.

4.4 Creating a route

A route is a series of waypoints used to navigate a course. A route is represented on-screen by a series of waypoints linked together by a line.

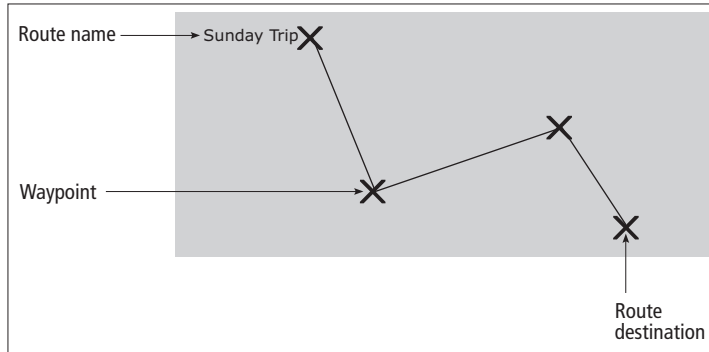

Up to 150 routes can be added to your unit, each consisting of up to 50 waypoints.

Notes:

- When a route is being built it is not active and does not affect any current navigation.
- A waypoint can be included more than once in a route, but cannot be used consecutively.
- A new route can be created when the route list is full, but on saving, you will be prompted to choose an existing route to overwrite.
- You cannot save a new route if any of the waypoints contained in it are active.

Building a route

Routes can either be built on screen or by using the waypoint list you can:

- Build a temporary route that you follow immediately (Quick Route).
- Build and save a route for later use, in which case the route is stored in the route list.
- Convert a track into a route.

To build (and follow) a route using new waypoints

1. Press the **ROUTES** softkey.
2. Select **BUILD NEW ROUTE**.
3. Move the cursor to the position that the waypoint is required.
4. Press **PLACE WAYPOINT**.
5. Repeat steps 3 and 4 until you have built the set of waypoints needed to make the route.
6. Press **SAVE ROUTE** or **FOLLOW (QUICK) ROUTE**.

To build (and follow) a route using existing waypoints

1. Press the **ROUTES** softkey.
2. Select **BUILD NEW ROUTE**.
3. Highlight the waypoint that you want to use in the new route.
4. Press **USE THIS WAYPOINT**.
5. Repeat steps 3 and 4 until you have built the set of waypoints needed to make the route.
6. Press **SAVE ROUTE** or **FOLLOW (QUICK) ROUTE**.

To build a new route using the waypoint list:

1. Press the **ROUTES** softkey.
2. Select **BUILD NEW ROUTE**.

3. Press **USE WAYPOINT LIST**.
4. From the waypoint list, select the first waypoint to be used in the route.
5. Continue to select waypoints until your route is complete.

Making changes to the route being built

If you make an error whilst building a route you can:

- Undo the last waypoint in an on-screen route build.
- Delete a waypoint from the new route list in a waypoint list route build.
- Abandon the route build.

To undo the last waypoint in an on-screen build:

1. Press the **UNDO WAYPOINT** softkey.

The waypoint and its associated dotted line is removed from the chart and the cursor moves back to the previous waypoint. Pressing the **UNDO WAYPOINT** softkey repeatedly will remove successive waypoints from a route.

To delete a waypoint from the new route list:

1. Use the trackpad to highlight the waypoint to be removed from the route list.
2. Press the **REMOVE WAYPOINT** softkey.

The remaining waypoints will renumber accordingly.

To abandon the route build:

1. Press the **CANCEL** button.

Saving a route

Once a route has been built, you have the option to either:

- Save and immediately follow the new route, or,
- Save the new route for later use

A route that is saved and immediately followed is called the 'Quick Route'. If a quick route already exists, saving the new route will overwrite the existing quick route.

To follow the Quick Route:

1. Press the **FOLLOW (QUICK ROUTE)** softkey.

To Save a route (for later use):

2. Press the **SAVE ROUTE** softkey. The Save Route Dialog box appears.
3. Press the **EDIT NAME** softkey and enter the new route name.
4. Press the **EDIT COLOR** softkey and enter the new route color.
5. Press **OK** to accept the changes.

4.5 Following a route

You select a route to follow either by either:

- Selecting the Quick Route option at the time you build the route. See [Building a route on page 43](#)
- Highlighting it with the cursor
- Selecting it within the routes list.

When you begin to follow a route it becomes **Active**.

To select a route to follow with the cursor

1. Move the cursor over either the route line or waypoint symbol.
2. Press the **FOLLOW THIS ROUTE** or **FOLLOW FROM HERE** softkey.

To select a route to follow in the routes list

1. Press either the **GOTO** or **ROUTES** softkey.
2. Press the **FOLLOW ROUTE OPTIONS** softkey.
3. On the Route List menu, select the route you want to follow.
4. Press the **FOLLOW ROUTE** softkey.

To stop following a route

1. Press the **STOP FOLLOW** softkey.

Reverse order

This option reverses the waypoints in a route, i.e the last waypoint of the original route becomes the first, and re-orders the waypoint accordingly. The route name moves to what is now the first waypoint and the system automatically activates the reverse follow route function.

To follow a route in reverse order:

1. Press either the **GOTO** or **ROUTES** softkey.
2. Press the **FOLLOW ROUTE OPTIONS** softkey. The route list appears.
3. Use the trackpad to highlight and select the route you want to follow.
4. Press the **REVERSE AND FOLLOW** softkey.

Arriving at a waypoint

As your boat approaches a waypoint arrival alarm provides a warning dialog and an alarm sound.

To acknowledge and proceed to the next waypoint:

1. Press the **ACKNOWLEDGE** softkey.

See also:

You can set the approach distance (radius) at which the waypoint arrival alarm will sound. Refer to [Alarm Setup Menu on page 132](#).

Advancing to the next waypoint

You can tell the system to ignore the next waypoint in your route, and advance directly to the waypoint after it.

To advance to the next waypoint in a route:

1. Either, use the trackpad to move the cursor over the route, or press the **GOTO** softkey.
2. Press the **ADVANCE WAYPOINT** softkey.

Note: If the next waypoint is also the last in the route, pressing **ADVANCE WAYPOINT** takes you to the first waypoint in the route.

4.6 Editing routes

A saved route can be edited in a variety of ways, you can:

- Change the course of a route.
- Change the name or color of a route.
- Erase a route.

It is possible to edit an active route with the exception of the target waypoint.

If a waypoint becomes the target during an edit, the system automatically cancels the edit and the waypoint retains its original position and data.

To select a route to edit:

1. Press the **ROUTES** softkey.
2. Press the **REVIEW AND EDIT ROUTES** softkey. The routes list appears.
3. Use the trackpad to highlight the route to be edited.
4. Press **OK**.

OR

5. Use the trackpad to move the cursor over the route to be edited.
6. Press the **REVIEW AND EDIT ROUTES** softkey.

Change the course of a route

The course of a route can be changed by adding, moving and removing waypoints:

To add an existing waypoint to a route:

1. Press the **AMEND ROUTE COURSE** softkey.
2. Press the **USE WAYPOINT LIST** softkey. The waypoint list appears.

3. Use the trackpad to highlight the position for the added waypoint in the right hand column.
4. Use the trackpad to highlight the waypoint you want to add to the route in the left hand column.
5. Press the **INSERT WAYPOINT** softkey.
6. Press the **SAVE ROUTE** softkey.

To create and add a new waypoint to a route:

1. Use the trackpad to move the cursor over the route that you want to add a waypoint to.
2. Press the **INSERT WAYPOINT** softkey.
3. Use the trackpad to move the cursor to the position of the new waypoint.
4. Press the **PLACE WAYPOINT** softkey.

To move a waypoint within a route:

1. Use the trackpad to move the cursor over the waypoint to be moved.
2. Press the **MOVE WAYPOINT** softkey.
3. Use the trackpad and cursor to drag the waypoint to its new position.
4. Press **OK**.

To remove a waypoint from a route:

1. Use the trackpad to move the cursor over the waypoint to be removed.
2. Press the **REMOVE WAYPOINT** softkey.

Change a route's name or color

If you have many routes stored in your system, it can be useful to give them individual names or mark them with a color.

To change the name and color of a route;

1. Press the **ROUTES** softkey.
2. Press the **REVIEW AND EDIT ROUTES** softkey. The routes list appears.
3. Press the **EDIT NAME AND COLOR** softkey.
4. Press the **EDIT NAME** softkey and enter the new route name.
5. Press the **EDIT COLOR** softkey and enter the new route color.
6. Press **OK** to accept the changes.

Erasing a route

Any route stored in the route list can be erased, with the exception of the one that you are following.

Erasing a route will only delete the waypoints used by that specific route. Waypoints used within other routes are not affected.

To erase a route:

1. Press the **ROUTES** softkey.
2. Press the **REVIEW AND EDIT ROUTES** softkey. The routes list appears.
3. Use the trackpad to highlight the route to be erased.
4. Press the **ERASE ROUTE** softkey.

Timed routes

Details of all routes are held in the routes list. This list can be used in conjunction with the time and speed over ground (SOG) options to show a journey time or estimated time of arrival (ETA) and the actual or planned SOG.

If a route is active, the data will be updated to show bearing, distance and time from your boat's current position.

To view time and SOG data:

5. Either use the trackpad to move the cursor and highlight a route on-screen, or, highlight a route in the routes list.
6. Press the **ROUTE DETAILS** softkey.
7. Toggle between **TIME** and **SOG** settings to show the relevant data as required.

4.7 Course deviation indicator

The CDI gives you a 'rolling road' representation of your progress toward an active waypoint, with navigation data displayed alongside.

The rolling road covers an area of sea that corresponds to the Cross Track Error (XTE) limits specified in the Setup menu.

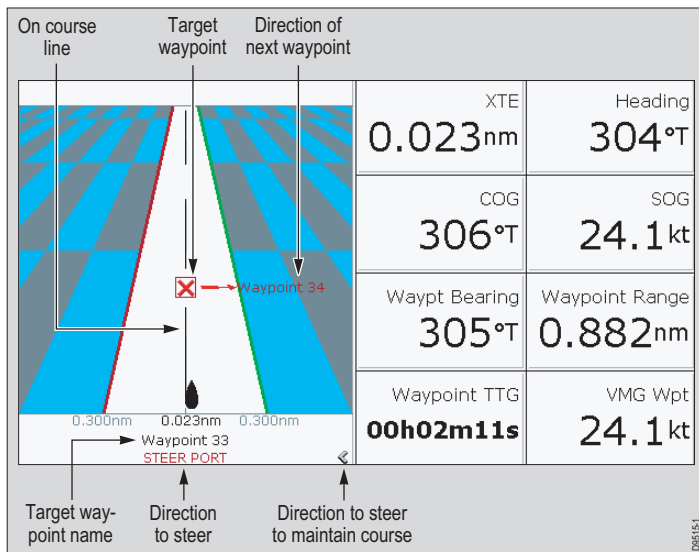

To open the CDI application:

1. Press and hold the **PAGE/MENU** button.
2. Open the Select Page Set menu.
3. Select a page set that includes the CDI application.
4. Press **OK** to confirm your selection.

Steering instructions

The steering instructions below the rolling road tell you what correction is needed to maintain your course and arrive at the target waypoint.

Instruction	Cause
STEER STARBOARD	XTE error to port is more than a 1/4 of the maximum XTE error limit in the Setup menu
STEER PORT	XTE error to starboard is more than a 1/4 of the maximum XTE error limit in the Setup menu

Indicator-arrows either side of the steering instruction (pointing towards the centre line) tell you how great or small the error is. The greater the error, the greater the number of arrows.

Correct your course by steering in the direction indicated by the arrows.

Resetting cross track error

Whilst following a route or navigating to a waypoint, it is possible to restart the cross track error (XTE). This starts a new course from your boat's current position to the current target waypoint.

The restart XTE function is useful if you find that you are off track and want to travel directly to the target waypoint, rather than return to the original track.

Although restarting the XTE causes your boat to change course, it does not change the saved route.

To restart XTE:

1. With the route active, press the **RESTART XTE** softkey.

4.8 Using tracks

A track is an on-screen trail that represents the course you have taken. This trail is made up of a series of track points which are created automatically. You can save the track to create a permanent record of where you have been.

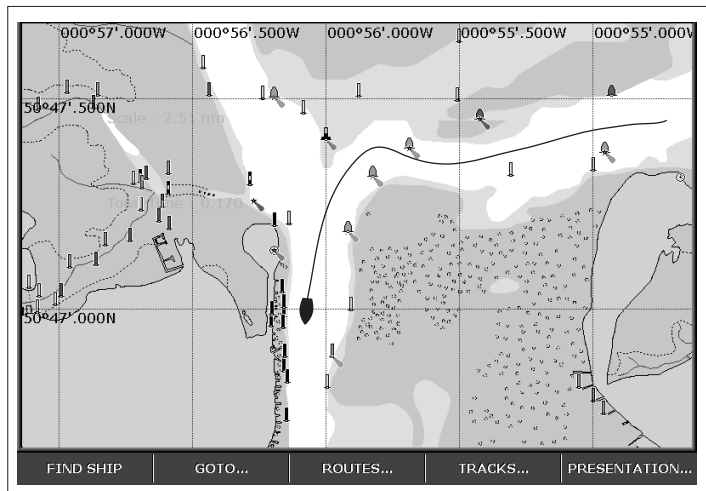

Creating a track

There is a maximum number of track points that can be stored by your system. A warning will be shown if the track you are creating uses the maximum number of track points and, if you continue to record the track, start to overwrite the earliest track points with newer ones.

To start recording a track;

1. Press the **TRACKS** softkey.

2. Press the **START TRACK** softkey.

To stop recording a track:

1. Press the **TRACKS** softkey.
2. Press the **STOP TRACK** softkey.
3. Press **SAVE TRACK**, or **DISCARD TRACK** depending on what you want to do with the track.

Creating a route from a track

To create a route from a current track:

This method takes a 'snapshot' of the track to date, converts it to a route and then continues to lay the track.

1. Use the trackpad to highlight the required track.
2. Press the **CREATE ROUTE FROM TRACK** softkey.
3. Press **YES** to give the route a name, or **NO** to store the route with the next default route number.

To create a route from a saved track:

1. Press the **TRACKS** softkey.
2. Press the **CREATE ROUTE FROM TRACK** soft key to open the track list.
3. Select the track to be converted.
4. Press the **CREATE ROUTE FROM TRACK** soft key.

Editing and deleting tracks

You can change the name and color of a track, or delete a stored track using the Review and Edit Tracks functions.

To select a track for editing:

1. Use the trackpad to highlight the required track.
2. Press the **REVIEW AND EDIT TRACKS** soft key,

Or

1. Press the **TRACKS** soft key to open the track list.
2. Press the **REVIEW AND EDIT TRACKS** soft key.

You can now edit the name and color of a track, or delete it from the system.

4.9 Measuring distance, range and bearing

The A-Series provides a number of tools to measure distance, range and bearing.

Functions	Distance between points	Range from vessel	Bearing
Range Rings	Yes (approx.)	Yes (approx.)	-
Ruler	Yes		Yes
Cursor position	-	Yes	Yes

Using the cursor to measure distance and bearing

You can determine the exact position, distance and bearing to the position of the cursor by referring to the cursor position (Csr Pos) data in the databar.

Range rings

Range rings are a series of concentric circles a set distance apart. They are used to help assess the distance between objects on the chart.

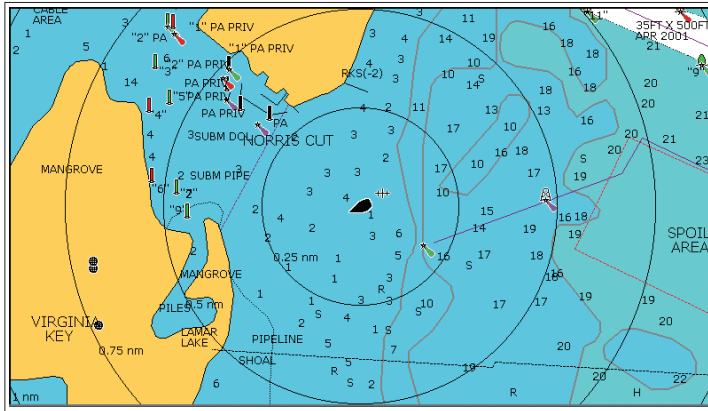

To switch range rings on or off

1. Press the **PRESENTATION** softkey.
2. Press **CHART LAYERS AND DATA** softkey.
3. Press **CHART LAYERS**.
4. Use the **TRACKPAD** to select the **RANGE RINGS** layer and turn them on or off as required.
5. Press **OK** to save your settings.

Ruler

The chart application includes a ruler which accurately measures the distance and bearing between two points.

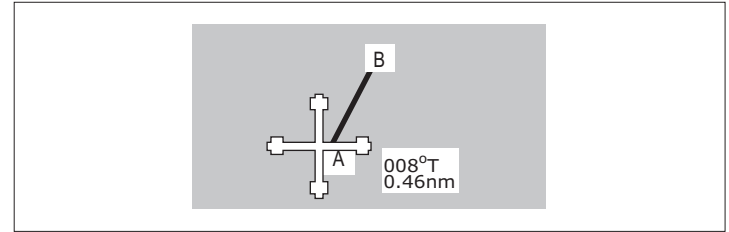

To use the ruler

1. Position the cursor at the start-point of the measured distance.
2. Press the **PRESENTATION** softkey.
3. Press **CHART LAYERS AND DATA** softkey.
4. Press the **RULER** softkey.
5. Move the cursor to the end-point of the measured distance.
6. Press **OK**.

To move the ruler

1. To move the **start-point**, press **ADJUST A**.
2. To move the **end-point**, press **ADJUST B**.

To clear the ruler

1. Press **CLEAR RULER**.

4.10 Chart presentation

The chart has a number of content layers and display modes providing different kinds of display and information.

Chart layers

You can overlay data onto a chart window to give greater depth of information. The overlays available are:

- AIS Objects
- Range Rings
- 3D locator
- Heading vector
- COG vector
- Tide and wind arrows

To switch layers on or off

1. Press the **PRESENTATION** softkey.
2. Press **CHART LAYERS AND DATA** softkey.
3. Press **CHART LAYERS**.
4. Use the **TRACKPAD** to select the appropriate layer and turn it on or off as required.
5. Press OK to save your settings.

Vectors and arrows

The vectors and arrows are a chart presentation layer. They present system data with relation to your vessel on the chart. This can assist in monitoring your boat's course.

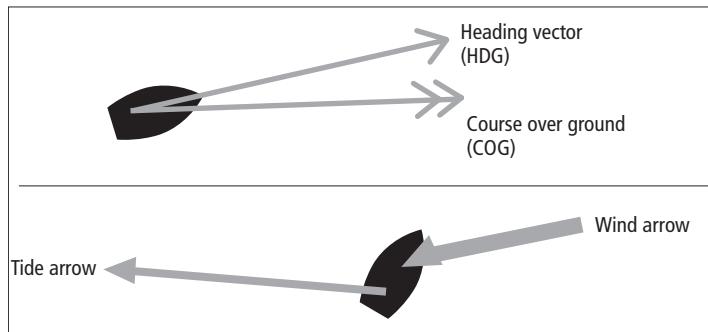

Note: The vectors require appropriate data (e.g. wind data from a wind instrument, SOG & COG calculated from the GPS fix).

To switch vectors on or off

1. Press the **PRESENTATION** softkey.
2. Press **CHART LAYERS AND DATA** softkey.
3. Press **CHART LAYERS**.
4. Use the **TRACKPAD** to select the appropriate layer and turn it on or off as required.
5. Press **OK** to save your settings.

Vector length

The length of the vectors is determined by the distance your boat will travel in a given time (This time can be set using the set up menu) at the current speed.

Wind and tide arrows are shown on the chart as lines with solid arrow heads pointing in the direction of the wind or tidal set. Wind arrows point towards your boat, tidal arrows point away from your boat. The greater the strength of the wind or tide, the thicker the line appears.

Chart mode and orientation

Mode settings enable you to control how information is shown on the chart, they let you change such things as how movement is represented, the position of your boat's on-screen representation and the chart orientation.

Orientation

Orientation settings control the way the chart is drawn in relation to your boat's position and course.

To set the chart orientation:

1. Press the **PRESENTATION** soft key.
2. Press the **CHART MODE AND ORIENTATION** soft key.
3. Press the **ORIENTATION** soft key to toggle it to your preferred choice.

Orientation options:

- **North Up (N-Up)**
This is the default mode with the chart static and orientated with true north to the top of the screen. As your boat's heading changes, the boat symbol rotates accordingly.
- **Heading Up (H-Up)**
In this mode the on-screen boat symbol remains static, with the current heading facing the top of the screen. When you change the boat's heading the chart rotates accordingly. However, to prevent continual chart rotation as your boat yaws, the chart will only update if the heading change is 10° or greater. You cannot select Head-Up mode if the motion mode is set to True.
- **Course Up (C-Up)**
In this mode the chart is static and orientated with your boat's current course facing the top of the screen. As your boat changes heading, the on-screen boat symbol moves accordingly. When a new course is selected, the chart redraws to show the new course to the top of the screen.

Motion mode

Motion mode controls how your boat's progress relative to the chart is represented on screen.

To set the motion mode:

1. Press the **PRESENTATION** soft key.
2. Press the **CHART MODE AND ORIENTATION** soft key.
3. Press the **MOTION MODE** soft key to select your preferred option.

Motion mode options

- **Relative motion (RM)**
This is the default motion mode. In this mode the chart is re-drawn relative to your boat's position as your journey progresses, so that your boat is always shown in the same place on-screen.
 - **True motion (TM)**
In this mode the chart view remains static and your boat is shown moving across it as progress is made. As the boat's position approaches the edge of the screen, the chart area is redrawn to show what is ahead of you.
- Note:** True motion cannot be selected if the orientation is set to Head Up.
- **Relative motion with vessel offset**
In relative motion mode you have the option to specify the position of your boat in relation to the chart view.

4.11 Chart detail

You can change the features and level of detail displayed on the chart. For example you may wish to hide certain features if there are many objects displayed in a small geographic area.

Show / Hide waypoints, routes and tracks

There are a number of options to show / hide various aspects of the waypoint, route and track information.

To show or hide waypoints by group or symbol

1. Press the **PRESENTATION** softkey.
2. Press **SHOW/HIDE WAYPOINTS**.
3. Toggle between **SYM** and **GROUP** on the **SHOW BY** softkey.
4. Select the relevant group and toggle its setting to **SHOW** or **HIDE** on the **ON CHART** softkey.

To show or hide waypoint names

1. Press the **PRESENTATION** softkey.
2. Press **SHOW/HIDE WAYPOINTS**.
3. Toggle to the required setting with the **WAYPOINT NAME** softkey.

To show or hide waypoint index numbers

1. Press the **ROUTES** softkey.
2. Press **SHOW/HIDE ROUTES**.
3. Toggle settings with the **WAYPOINT INDEX** softkey.

To show or hide routes and tracks

1. Highlight a route or track and press the **HIDE** softkey.

or

1. Open the Route or Track list.
2. Highlight a route or track in the list.
3. Toggle between **SHOW** and **HIDE** settings with the **ROUTE ON CHART** or **TRACK ON CHART** softkey.

Note: The active route is always displayed irrespective of the display status.

Declutter

Declutter allows you to reduce the amount of detailed information shown on the chart.

To turn declutter ON or OFF:

1. Press the **PRESENTATION** soft key.
2. Press the **DECLUTTER** soft key to toggle ON or OFF as required.

Turning the declutter feature ON hides the following cartographic objects:

- Chart boundaries
- Spot soundings
- Depth contours
- Light sectors
- Cautions and routing data
- Land and marine features
- Business services (if available on the cartography you are using)

If using declutter does not hide a particular feature, you can hide features individually using the Cartography Set Up Menu.

4.12 Journey planning

Your electronic charts contain a number of features to help you plan your journey.

Note: Certain features require additional or upgraded cartography available within Navionics chart cards. For full details of all the features available with each card type, refer to the Navionics website - www.navionics.com or www.navionics.it

Tide and current information



CAUTION: Tides and currents

Whilst every effort is made to ensure the accuracy of data used for tides and currents, this information can be influenced by local conditions. It is therefore recommended that consideration is given to obtaining local information wherever possible.

Tidal diamonds

Tide and current information is associated with the tidal diamonds on the chart.

To show information using a tidal diamond:

1. Use the trackpad to move the cursor over the required tidal or current diamond.
2. Press **OK**. A dialog box appears showing tidal or current information as appropriate for the selected area.

3. Press the **TIDAL DATA** or **CURRENT DATA** soft key. A dialog box appears containing additional data and a tidal or current curve as appropriate for the selected area.

You can now use the trackpad to select the relevant time and the soft keys to select the relevant date.

To show information using the FIND NEAREST soft key:

1. Use the trackpad to move the cursor to the required position.
2. Press **OK**.
3. Press the **FIND NEAREST** soft key. A dialog box appears listing the available options.
4. Use the trackpad to highlight Tidal Stations or Current Stations as applicable.
5. Press the **FIND** soft key. A dialog box listing the nearest stations appears.
6. Use the trackpad to select and highlight the required station.
7. Press **OK**.
8. The relevant information is shown in the dialog box.

Animated tide and current data

Requires navionics chart card with animated tide data.

The animations provide a visual cue to the movement of currents and tides for times which you have specified.

Animations cover a 24-hour period and you are able to choose whether to view the whole or part of it. You can also choose to view the animation continuously or step through it in increments.

To view animated tide and current data:

1. Use the trackpad to move the cursor over the required tidal or current diamond.
2. Press **OK**.

3. Press the **ANIMATE** soft key. The animation screen opens with the animation paused.
4. Press the **ANIMATION PLAY/PAUSE** soft key. The animation starts. The time and date of the animation is shown in the status bar; the animation always starts from the current time.

Controlling the animation

When you open the tide and current animation screen, the toolbar shows a set of soft keys that enable you to control the animation:

- Start/Stop the animation.
- Step the animation forward or back in time.
- Set the size of the step.
- Select a date for the animation.

The animation plays in a loop; when it reaches the end of a 24-hour period, it starts again at the beginning.

To start or stop an animation:

1. Press the **ANIMATION PLAY/PAUSE** soft key.

To step through an animation:

1. Press the **STEP BACK** or **STEP FWD** soft keys as required.

To set the step interval:

With the animation paused:

1. Press the **SET TIME INTERVAL** soft key.
2. Use the trackpad to adjust the time interval within the range of 15 to 120 minutes.
3. Press **OK** to save the new time interval.

To set the animation date:

4. Press the **SET DATE** soft keys. The following soft key options appear in the toolbar:

TODAY'S DATE	Set the animation date to the current date
PREV DATE	Set the animation date to 24-hours previous to the current date
NEXT DATE	Set the animation date to 24-hours after the current date.
EDIT DATE	Opens the edit date dialog box: use the trackpad to enter the date of the animation required

5. Press OK to save the new date and return to the tide/current animation screen which will update to show the animation for the selected date.

Press **CANCEL** at any time to return to the tide/current animation screen with the date unchanged.

Bathymetric information

Requires navionics chart card with bathymetric (Fish'n'Chip) data.

To show bathymetric information:

1. Press the **PRESENTATION** softkey.
2. Press the **CHART LAYERS** softkey.
3. Press the **CHART TYPE** softkey.
4. Toggle the soft key between FISH and NAV according to your requirements.
 - **FISH** - shows bathymetric information/

- **NAV** - shows the standard chart view.

If FISH is selected and no data is available for the current position, (FISH) is shown in the databar to indicate that the system is in bathymetric mode but does not have data.

Details of objects and features

Many objects shown on the chart have detailed information associated with them. Some of this information is shown automatically whenever the object is highlighted with the cursor.

To view details of objects or features:

1. Use the trackpad to move the cursor over an object.
If basic information is available for the object it will be shown.
2. Press **OK**.
3. If available, detailed information for the object is shown.

To find nearby objects or features:

1. Use the trackpad to move the cursor over an object.
2. Press **OK**.
3. Press the **FIND NEAREST** softkey.
4. Select the appropriate options from the on-screen lists.

Details of ports, port and business services

Requires navionics chart card with port and business services data.

Various symbols on the chart indicate the location of business services and points of interest.

These locations are indicated using the following symbols.

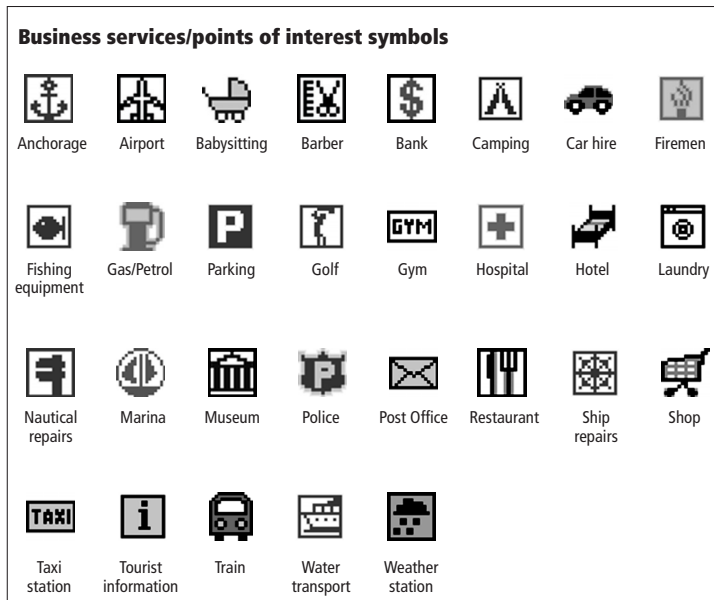

Using the trackpad to place the cursor over a symbol and pressing **OK** causes a pop-up to appear, giving the following information:

- Port/Port or Business service name.
- Address.
- Telephone number.

- Type of business/services available.

To display port services

1. Highlight a port symbol.
2. Press **OK**.
3. Highlight a service.
4. Press the **VIEW DETAILS** softkey.

or

1. Press **OK**.
2. Press the **SEARCH BY NAME** softkey.
3. Press **EDIT NAME**.
4. Enter the port name (or the first few characters of the port name).
5. Press **SEARCH**.
6. If the search returns more than one port, select the port you are interested in.
7. Select your service.
8. Press the **VIEW DETAILS** softkey.

Pilot book information

The pilot book information option enables you to view detailed information normally contained in a nautical pilot book.

To view pilot book information

1. Highlight a port symbol.
2. Press **OK**.
3. Select Pilot Book and press **VIEW PILOT BOOK**.
4. Use the toolbar to navigate around the pilot book.

Panoramic and aerial photographs

Requires navionics chart card with aerial photography.

In some regions an aerial photo overlay is available to enhance your chart view. The overlay covers navigable waters and an area up to 3 miles from the coast including US lakes and inland waters.

The availability of a panoramic photograph is indicated on the chart by the camera icon. This is placed on the chart at the point the photograph was taken, with the viewpoint indicated by the angle of the icon.

To show a panoramic photograph:

1. Use the trackpad to move the cursor over the camera icon.
2. Press **OK**. The panoramic photograph appears.

or,

1. Use the trackpad to move the cursor over a port symbol.
2. Press **OK**. The port information dialog box appears.
3. Use the trackpad to highlight **PHOTOS**.
4. Select a numbered photograph from the list.
5. Press the **VIEW PHOTO** soft key.

To overlay aerial photography:

1. Press the **PRESENTATION** soft key.
2. Press the **CHART LAYERS** soft key.
3. Toggle **AERIAL OVERLAY** to **ON** or **OFF** as required.
4. Use the trackpad **Left / Right** to set the overlay opacity.

Overlay area

You can choose whether the aerial overlay is shown for land areas only, or for land and sea areas.

- **On land** shows a normal chart view for sea areas and overlays aerial photography on areas of land. This can help interpret your surroundings while keeping important navigational data visible.
- **On land and sea** shows aerial photography of both land and sea areas. This can help in distinguishing between deep and shallow water (dark blue and light blue, respectively), and to view land features simultaneously.

The overlay area can be set up using the Aerial Photo Overlay functions of the Cartographic Setup Menu.

To specify the overlay area

1. Open the **Cartography Setup Menu**.
2. Select **Aerial Photo Overlay**.
3. Choose your preferred setting.

4.13 Chart setup

There are three ways you can change chart settings:

- Chart Setup Menu.
- Cartography Setup Menu.
- Presentation softkey (see [page 52](#)).

Changes are retained when you power off.

To open the Chart Setup Menu

1. Press and hold the **PAGE/MENU** button.
2. Highlight **Chart Setup**.
3. Press the right-arrow on the trackpad.

FUNCTION	OPTIONS
Object Information	<p>OFF No info pop-up is displayed but detailed data can still be displayed by pressing OK.</p> <p>All ON Displays an information pop-up for all objects.</p> <p>Points ON Displays an information pop-up for objects selected with the cursor only.</p>
Vector Length Specify a time period for drawing COG and heading vectors.	<p>3 Mins</p> <p>6 Mins</p> <p>Infinite</p>

FUNCTION	OPTIONS
Vector Width Sets the width of the COG and HEADING chart vector lines.	<p>Thin</p> <p>Normal</p> <p>Wide</p>
Record Vessel Track By	<p>Auto System automatically creates track points.</p> <p>Time For track point creation by a specified time.</p> <p>Distance For track point creation by a specified distance.</p>
Track Interval Option availability depends upon Record Vessel Track By setting.	<p>Time Specify time between track points. 2/5/10/30 seconds 1/3/5/10/30 minutes</p> <p>Distance Specify distance between track points. 0.02/0.05/0.1/0.2/0.5/1.0 nm</p>
Datum See additional information below.	<p>WGS 84. List of datum provided.</p>
Chart Offset Corrects positional errors in cartography.	<p>ON</p> <p>OFF</p>

Datum

The Chart application and your paper charts must use the same datum to correlate accurately. The default datum for the display is WGS1984. If that is not suitable, you can change it to one from the set provided under the Datum option on the Chart Setup menu.

If you have a Raymarine GPS attached, it will automatically update when you adjust the datum. If you use a third-party GPS, you need to update its datum separately.

CAUTION: Changing the chart datum does not cause any waypoints or routes stored in the chartplotter to move on the display, although their latitude and longitude changes to reflect the new datum. When you add waypoints to the waypoint list, make sure they are referenced to the same datum.

Chart offset and cartography setup

This feature allows you to move the position of the chart to correct positional errors in the cartography. The adjustment is indicated as a distance north/west (+ve) or south/east (-ve) from your vessel to a maximum of 1000m. An indicator in the chart window tells you when chart offset is enabled.

Restore chart offset to zero when you begin using a chart with the correct georeference.

Please report chart errors to Navionics (see [page 148](#)).

To change chart offset

1. Select **Chart Offset** in the Chart Setup Menu.
2. Toggle **OFFSET** to **ON**.
3. Press the **SET OFFSET** softkey.

4. Adjust the North/South and East/West offset values by pressing the corresponding softkey and using the trackpad.

To restore chart offset to zero

1. Select **Chart Offset** in the Chart Setup Menu.
2. Press the **SET OFFSET** softkey.
3. Press **CLEAR OFFSET**.

To open the Cartography Setup Menu

1. Press and hold the **PAGE/MENU** button.
2. Highlight **Cartography Setup**.
3. Press the right-arrow on the trackpad.

FUNCTION	OPTIONS
Chart Display The level of detail shown on the chart.	Simple Detailed Extra detailed
Chart Grid Grid lines of latitude and longitude.	ON OFF
Chart Text Text appearing on the chart e.g. place names etc.	ON OFF
Chart Boundaries The line indicating the extent of the chart.	ON OFF
Spot Soundings Number on the chart indicating depth.	ON OFF

FUNCTION	OPTIONS
Safety Contour Areas with depths shallower than the specified value are shaded in a darker blue than those areas with depths greater than the specified value.	OFF 7ft 10ft 16ft 20ft 33ft 66ft (Contour always drawn at or deeper than the selected depth).
Depth Contour Set the interval for depth contours.	OFF 16ft 20ft 33ft 66ft ALL
Hide Rocks	ON / OFF
Nav. Marks	ON OFF
Nav. Marks Symbols The set of symbology used for navigation marks. Corresponds to paper charts.	International US
Light Sectors The sector of light cast by a fixed beacon.	ON OFF
Caution & Routing Data	ON OFF

FUNCTION	OPTIONS
Marine Features Cables, nature of seabed points, tide station, current stations and port information.	ON OFF
Land Features The cartographic features that are displayed on the land.	ON OFF
Colored Seabed Areas In available areas (e.g. Portugal) this gives greater definition of seabed.	ON OFF
Background Color The color of background water when there is no Navionics cartography.	White Blue
Business Services The symbols indicating the location of a business	ON OFF
Aerial Photo Overlay The area displaying the aerial photo overlay	On Land and Sea On Land
Roads Major coastal roads	ON OFF
Additional Wrecks Extended wrecks data for new wrecks	ON OFF

Chart scale

Use the Range key to change the scale of your chart view. When you zoom in, you see a smaller area of the chart in more detail (larger scale). When you zoom out, you see a greater area of the chart in less detail (smaller scale).

The level of cartographic detail available at different scales varies: some charts provide detail at smaller scales than others.

If you select a chart scale that does not provide cartographic detail for your chosen area, the chart will use the most detailed level available for the surrounding area and stretch it to fit the selected scale. This means that you will never have blank or hatched areas on your screen. However, there could be some misalignment of objects which cross the chart boundary in this area.

Alarms

With the appropriate equipment installed and powered up, the following alarms may be triggered in the chart application:

- System (anchor, timer, alarm clock and temperature)
- Navigation (arrival and off-track)
- Fishfinder
- AIS
- Weather

When an alarm is triggered, a buzzer sounds and a pop-up window describing the alarm and how to clear it is displayed. In some cases, appropriate action is taken automatically by the A-Series unit. For example, following an arrival alarm, the next route leg is activated.

To configure alarms

1. Press and hold the **PAGE/MENU** button to open the Setup menu.

2. Select **Alarm Setup**.
3. Choose the appropriate sub-menu.
4. For detailed information about alarm configurations, see [Alarm Setup Menu on page 132](#).

Chapter 5: 3D chart application

5

REQUIRES UPGRADED CARTOGRAPHY

The 3D chart gives you an accurate, three-dimensional view of the area around your vessel. This can help you navigate more confidently if the area is new to you or if visibility is poor.

Navigation functions are available in the 3D chart.

Chapter contents

- [5.1 Safety and system requirements on page 65](#)
- [5.2 3D chart operation on page 65](#)
- [5.3 Using the standard and 3D charts together on page 69](#)
- [5.4 Aerial photography overlay on page 71](#)
- [5.5 Setting up the 3D chart on page 71](#)

See also...

- [The chart application on page 38](#)
- [Waypoints on page 30](#)

5.1 Safety and system requirements

Safety



WARNING: Navigation aid

This product is intended to serve only as an aid to navigation. Use of specific features such as AIS overlay, and various cartographic aids are meant only to aid safety and decision-making. These features cannot be relied upon as complete or accurate as their use and availability may vary locally. It is your responsibility to use caution, sound judgement, official government charts, notices to mariners and proper navigational skill when using this or any other electronic device.

Requirements

For the 3D chart application to operate correctly, your A-Series Multifunction Display System requires:

- A Navionics Chart card containing 3D cartography. (Not included with A-Series product)

5.2 3D chart operation

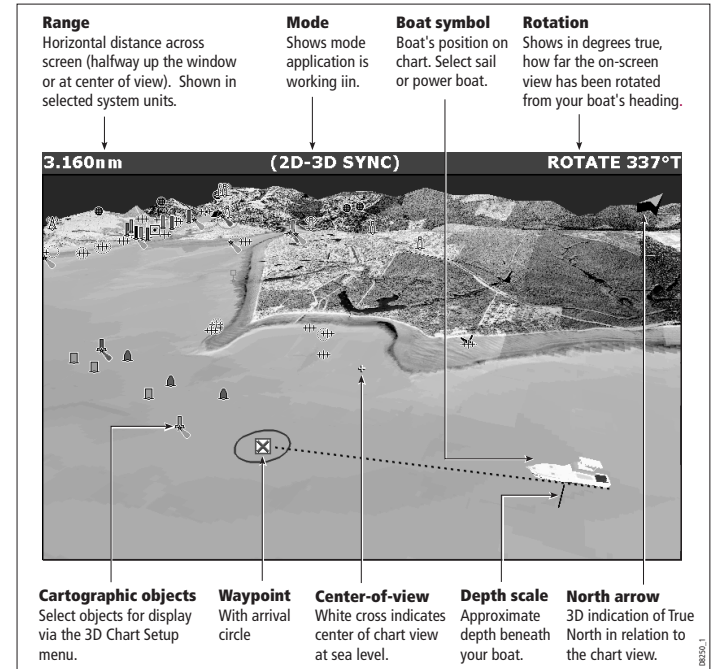

The 3D chart view includes the same cartographic objects and navigation features, like waypoints, as the standard chart. To move around the 3D chart, and to display your chosen area at the required scale, use pan and zoom as normal.

The 3D chart has the following features:

- Choice of operating modes; Active or Planning.
- Ability to change the view point.
- 360° rotation of the selected view.
- 1° - 90° pitch angle.
- Ability to exaggerate the view.
- Ability to synchronize 2D and 3D charts.
- Ability to indicate the area that your fishfinder transducer cone covers - if fitted.

The controls

The 3D chart is operated in a similar way to a conventional chart using the following controls:

Pan and Zoom

- Range button to zoom in or out.
- Trackpad to move around the chart.

Rotate and adjust pitch

In the 3D chart, you can also adjust **rotate** and **pitch** settings.

- **Rotate** softkey rotates the view between 0° and 359°.
- **Pitch** softkey adjusts the vertical angle of view between 1° and 90°.

Active and Planning modes

You can choose to view the 3D chart application in one of two modes:

- Active action mode.
- Planning mode.

Active mode is the default mode when entering the 3D chart application.

To select Planning mode:

1. Use the track pad to move around the map. The chart will enter planning mode.

To select Active action mode:

1. Press the **FIND SHIP** softkey. The display will return to active mode, with your vessel marker in view and facing forward.

Planning mode

Planning mode enables you to view an area of the chart, different to the one you are navigating in.

Planning mode is entered by using the trackpad to pan to the area of the chart you want to view.

All of the controls available in active motion mode are also available in planning mode. Chart control is the same as in active motion mode, but the mode information in the status bar is shown in brackets to indicate planning mode.

Active action mode

Provided that your system has a valid fix, this is the default mode when you first open the 3D chart application. The screen shows an aerial view of the 3D chart as if you are above your boat, slightly behind it and looking forward (eye point). As the boat moves forward the chart automatically updates and reveals the changing view ahead.

In active motion mode you can adjust the pitch of the view, but rotating or panning the chart will change into planning mode.

Changing the view

There are four view options to choose from: forward, aft, port and starboard.

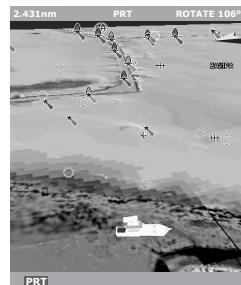

Port

- Eye point above and to starboard side of boat, looking to port.

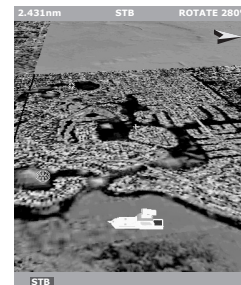

Starboard

- Eye point above and to port side of boat, looking to starboard.

8075_1

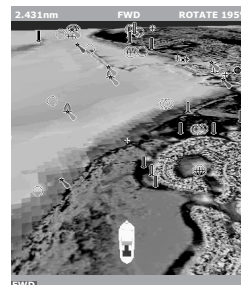

Forward

- Default view.
- Eye point above and behind the boat, looking forward.
- Pressing FIND SHIP resets to this view.



Aft

- Eye point above and in front of the boat, looking behind it.

8075_1

The current option is highlighted on the toolbar and displayed in the status bar.

To select the view option

1. Press the **PRESENTATION** softkey.
2. Press the **3D VIEW OPTIONS** softkey.
3. Toggle to your preferred view on the **VIEW TO** softkey.
4. Press **OK**.

Making the view clearer

If required, the 3D chart view can be made clearer using the following features:

- Exaggeration.
- Declutter.

Exaggeration

Sometimes it is easier to see certain topographical features if they are exaggerated. Adjusting the exaggeration has the effect of vertically stretching objects on the chart, making it easier to see their shape and position.

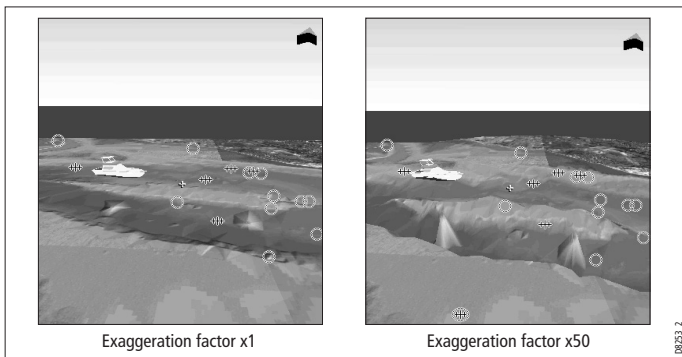

To adjust exaggeration

1. Press the **PRESENTATION** softkey.
2. Press the **3D VIEW OPTIONS** softkey.
3. Press **ADJUST EXAGGERATION**.
4. Use the trackpad to set your level of exaggeration.
5. Press **OK**.

Press **CANCEL** at any time to return to the previous exaggeration setting.

Declutter

In some circumstances, the quantity of information displayed on the chart can render its interpretation difficult.

The declutter feature removes some chart objects from view to make the chart clearer to read and navigation simpler.

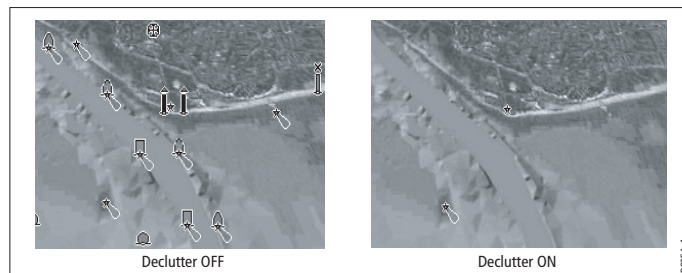

To turn declutter on or off

1. Press the **PRESENTATION** softkey.
2. Toggle to **ON** or **OFF** using the **DECLUTTER** softkey.

5.3 Using the standard and 3D charts together

If the area in which you are navigating is unfamiliar, or visibility is poor, working with standard and 3D chart windows side-by-side can give you extra confidence and information. With the charts displayed side by side, a comprehensive view of the surrounding area is available.

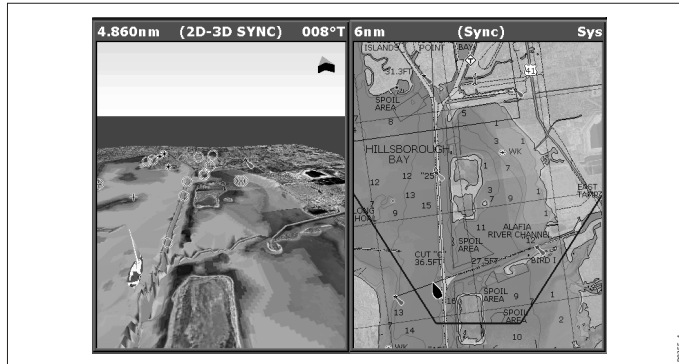

As with all multiple page sets, the active window is indicated by a red border. To make changes to an application it must be in the active window.

For information about setting up a page set to view two applications together, see [Split screen pages on page 27](#).

3D view locator

The view locator is a polygon displayed on the standard chart which outlines the boundaries of the area shown on the 3D chart. It is shown as a blue line extending from the virtual eye point icon.

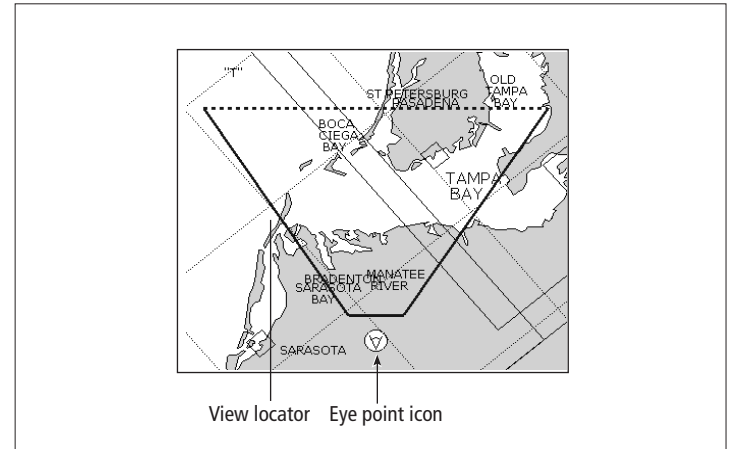

As you rotate, adjust pitch, pan or zoom the 3D chart view, the locator updates on the standard chart.

To display the 3D view locator

1. Make a standard (two-dimensional) chart window active.
2. Press the **PRESENTATION** softkey.
3. Press the **CHART LAYERS** softkey.
4. Toggle the **3D LOCATOR** setting to **ON**.
5. Press **OK**.

Chart synchronization

Chart synchronization enables you to synchronize heading, range and position information on the 2D and 3D charts.

When chart synchronization is **ON**:

- 2D/3D synchronization is flagged in the status bars.
- Pressing FIND SHIP from any synchronized application returns the 3D chart to the default view and synchronizes the 2D chart to the same view.
- Changes made to heading, range or position in **either 2D or 3D** charts are reflected in both windows.
- If the 2D chart view for the current window is set to SYSTEM, any changes made in a chart window will be reflected in all windows on all displays.
- If the 2D chart view for the current window is set to LOCAL, no other windows will be affected.

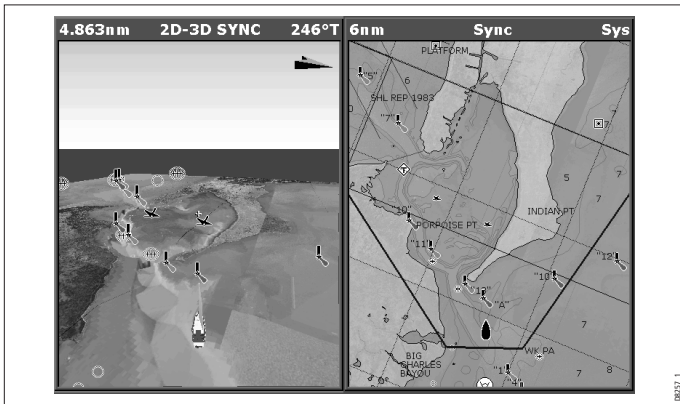

To synchronize the standard chart with the 3D chart

1. Make a 2D chart window active.
2. Press the **PRESENTATION** softkey.
3. Press **CHART MODE AND ORIENTATION**.
4. Toggle the **CHART SYNC** mode to **3D**.
5. Press **OK**.

5.4 Aerial photography overlay

You can overlay aerial photography onto the 3D image. This can help you interpret the chart view of your surroundings. Aerial photography is available for the navigable waters up to three miles inside the coastline. Beyond these limits, land appears green (on color charts) or grey (on black-and-white charts).

- Aerial photo overlay is controlled from the 3D chart Setup Menu.

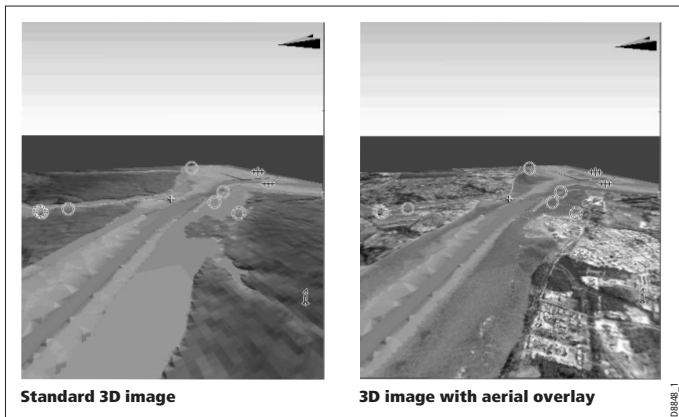

5.5 Setting up the 3D chart

The 3D chart setup menu is available from the system setup menu. For information on using the system setup menu refer to [Setup menus on page 25](#).

The 3D chart menu gives the following options:

FUNCTION	OPTIONS
Description	(Default in bold)
Centre-of-view indicator	ON
Centre of view indicator (marked with a white cross)	OFF
Boat symbol	Sail
Style of boat symbol shown on screen	Power
Boat size	Tiny
Size of boat symbol shown on screen	Small
	Medium
	Large
	High
Aerial Photo Overlay	ON
Overlay an aerial photo on the 3D chart	OFF
Chart text	ON
Text viewed on the 3D chart	OFF
Nav Marks	ON
Navigation marks viewed on the 3D chart	OFF

Chapter 6: Fishfinder application

D MODELS ONLY.

The fishfinder uses acoustic sounding to display fish, seabed structure, and underwater obstructions like wrecks.

6

Chapter contents

- [6.1 The fishfinder screen on page 73](#)
- [6.2 How the fishfinder works on page 73](#)
- [6.3 Interpreting the Fishfinder image on page 74](#)
- [6.4 Fishfinder Pre-set operation on page 75](#)
- [6.5 Changing the depth range on page 79](#)
- [6.6 Presentation options on page 80](#)
- [6.7 Placing waypoints on page 84](#)
- [6.8 Fishfinder alarms on page 84](#)
- [6.9 Fishfinder Setup Menu on page 85](#)

6.1 The fishfinder screen

The fishfinder displays a scrolling image of the seabed, updating from the right as your vessel makes progress.

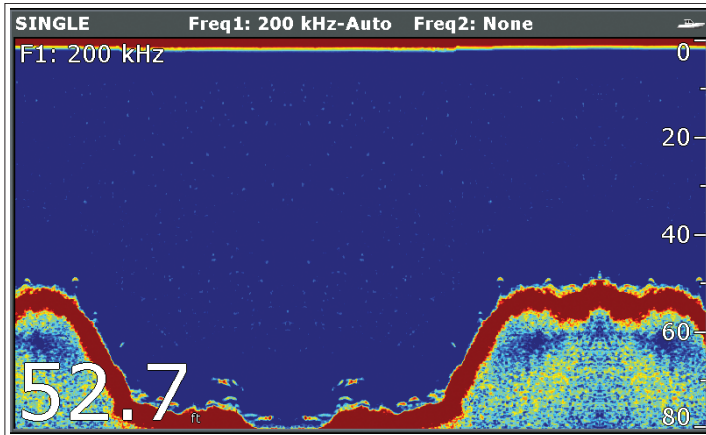

Status Icon

The fishfinder status icon is located in the top-right section of the monitor:



(animated icon)

Icon animated - fishfinder is operating.

Icon static - the fishfinder transducer is connected but not transmitting.

Icon greyed-out - no fishfinder transducer is connected.

6.2 How the fishfinder works

The fishfinder application uses a built in processor to interpret acoustic signals and build up a detailed picture of the seabed.

A transducer on the bottom of the boat sends pulses of sound waves into the water and measures the time it takes for the sound wave to travel to the bottom and back. The returning echoes are affected by bottom structure and by any other objects in their path, for example reefs, wrecks, shoals or fish.

The strength of the echoes is indicated on the display by different colors. You can use this information to determine the shape and make-up of the seabed, or the size of shoals, or of other objects.

6.3 Interpreting the Fishfinder image

Bottom indications

The bottom usually produces a strong echo. These images indicate the bottom conditions as follows:

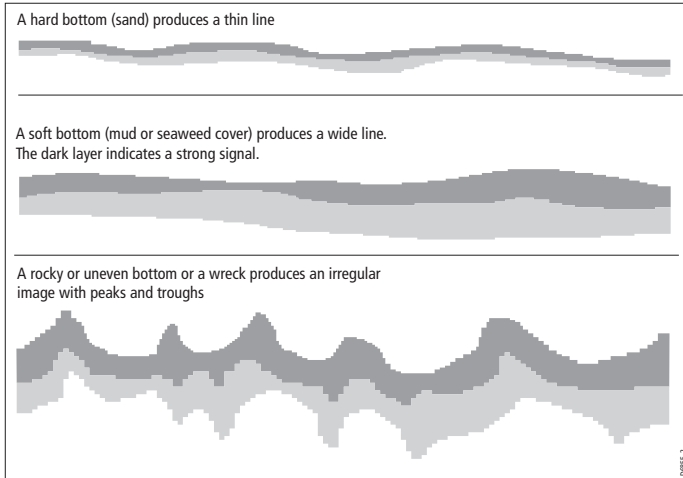

The dark layers indicate a good echo; the lighter areas weaker echoes. This could mean that the upper layer is soft and therefore allowing sound waves to pass to the more solid layer below.

It is also possible that the sound waves are making two complete trips – hitting the bottom, bouncing off the boat, then reflecting off the bottom again. This can happen if the water is shallow, the bottom is hard, or gain is set too high.

Factors influencing the readout

When an object is detected, it is displayed on screen as a mark.

The quality and accuracy of the display can be influenced by a number of factors including boat speed, depth, object size, background noise and transducer frequency.

Boat speed

The fishfinder's reading of the bottom and other objects is affected by your relative speed. Slower speeds return flatter, more horizontal marks; as your speed increases, the image will tend to thicken and arch, until at high speeds the bottom resembles a double line on the fishfinder display.

Object depth

The closer the target to the surface, the larger the mark on the screen. Individual target depths can be shown using the Target Depth ID function.

Water Depth

As sea depth increases, signal strength decreases, resulting in a lighter on-screen image of the bottom.

Object size

The larger an object is, the stronger its return on the fishfinder display will be.

However, the strength of return from fish depends upon the species' swim bladder, rather than the body size.

Transducer frequency

Your transducer may support a number of frequencies.

The same target will appear differently when the transducer frequency is changed. The lower the frequency, the broader the mark.

For information on setting the transducer frequency see [Transducer settings on page 87](#).

Clutter / Background noise

The fishfinder picture may be impaired by echoes received from floating or submerged debris, air bubbles or even the boats movement. This is known as 'background noise' or 'clutter' and is controlled by the gain modes. It is recommended that you allow your system to automatically control the ideal sensitivity level based on depth and water conditions. You can however adjust these settings manually if you prefer.

For information on reducing clutter and background noise see [Gain and power on page 80](#).

6.4 Fishfinder Pre-set operation

The fishfinder provides you with four preset configurations, available on the default toolbar. These are tailored to provide optimal operation in different circumstances.

Each preset has been configured to provide the best operating parameters for the fishfinder. However, it is possible to adjust the presets if necessary.

To select a preset mode

1. Press the appropriate softkey to select from:

- Single
- Dual
- Shallow
- Deep.

When you make a fishfinder window active, the title bar shows you which preset is selected, along with its settings.

Preset display modes

When a fishfinder preset is selected, its softkey label changes to **ADJUST**. Pressing this key allows you to configure the display mode settings to suit your requirements. (Changes to the display mode are saved with the preset at power-off.)

To change the display mode

1. Press the appropriate **ADJUST...** softkey.
2. For dual frequency screens, select **FREQ1** or **FREQ2** to select which frequency display you wish to change.
3. Press the **SELECT VIEW** softkey.
4. Use the track pad up/down to select the required display mode.
 - None
 - Zoom
 - Bottom Lock
 - A-Scope
5. Press **OK** when complete.

Zoom

The zoom display mode magnifies a region of the screen to display more detail. This zoom option lets you:

- Replace the standard fishfinder image with the zoomed image, or display the zoomed image alongside the standard fishfinder image.
- Set the zoom factor to a pre-defined level, or adjust it manually.
- Reposition the zoomed portion of the image to a different point in the display.

When the range increases, the area shown in the zoom window also increases.

Zoom split

With the zoom display mode you can split the screen and display the zoomed image alongside the standard fishfinder image (**ZOOM SPLIT**). The zoomed section is indicated on the standard fishfinder screen by a zoom box (see illustration below).

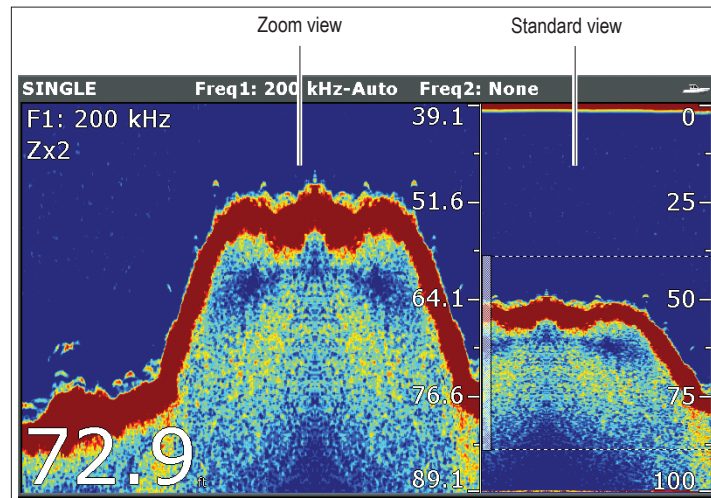

To select split-screen or full-screen:

1. Select **FULL** or **SPLIT** with the **ZOOM** softkey.

When the zoom function is active (**ZOOM FULL** or **ZOOM SPLIT**), you can either select a predefined zoom factor or adjust it manually.

To select the zoom factor:

1. Press the **ZOOM** softkey.
2. On the **ZOOM FACTOR** key, toggle between pre-defined settings or select xR to set a factor manually. For manual settings, adjust the zoom factor with the trackpad.
3. Press **OK** to accept your setting.

Adjusting the position of the zoomed area

When the zoom function is selected, the system automatically selects the zoom position so that the bottom details are always in the lower half of the display. If required you can reposition the portion of the image to be zoomed so that an alternative area is displayed.

To set the zoom position

1. Press the **ZOOM** softkey.
2. Select **MAN** with the **ZOOM POSITION** softkey.
3. Reposition the zoomed image using the trackpad.
4. Press **OK**.

Bottom lock and bottom shift

The Bottom Lock function applies a filter to flatten the image of the seabed and make any objects on or just above it easier to discern.

This feature is particularly useful for finding fish that feed close to the bottom.

Bottom Lock is selected for individual fishfinder windows and can replace or appear alongside the standard fishfinder image.

Adjusting the range of the bottom lock image allows you to view more bottom details. You can also reposition the image on screen to anywhere between the bottom of the window (0%) and the middle of the window (50%) by using the Bottom Shift control.

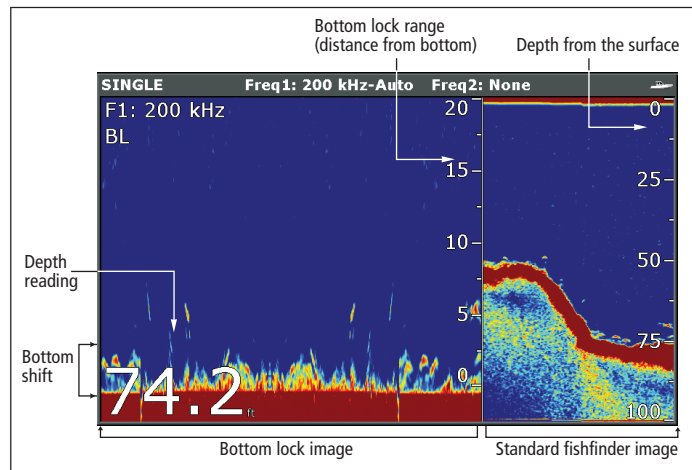

To adjust bottom lock

1. Toggle to **FULL** or **SPLIT**.
2. Use the appropriate softkeys and trackpad to set the range and bottom-shift values.

Using A-Scope to view a live image

The standard fishfinder display shows a historical record of fishfinder echoes. If required, you can display a live image of the bottom structure and the fish directly below the transducer by using the A-Scope feature. The width of the bottom area covered by the A-Scope is indicated by the number at the bottom of the window.

To display the A-Scope image

1. Press the **SELECT VIEW** softkey.
2. Use the track pad up/down to select **A-SCOPE** display mode.
3. Press the **A-SCOPE MODE** softkey to select the required display mode.

A-SCOPE Modes softkey

The A-Scope has the following display modes:

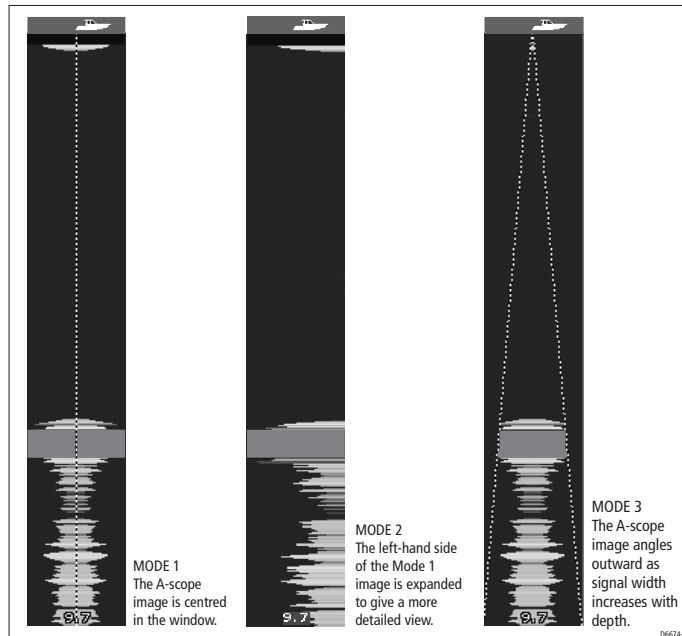

6.5 Changing the depth range

You can change the depth range for the fishfinder screen.

You can choose from either:

- an **automatic** adjustment whereby the display automatically show the shallowest required range.
- **manual** adjustment of the depth range, up to the maximum depth displayed on the scrolling bottom and A-Scope images. Changes to the range affect all fishfinder windows.

To open the Range Adjust toolbar

1. Press the **RANGE** button.

To select manual or auto range mode

1. Open the **Range Adjust** toolbar.
2. Toggle to **AUTO** or **MAN** on the RANGE softkey.
3. Press **OK**.

Range shift

The DSM automatically adjusts the display to keep the bottom in the lower half of the display window. Alternatively, you can shift the image within the current range. Changes to the range shift are reflected in all Fishfinder windows.

To shift the range image

1. Open the **Range Adjust** toolbar.
2. Press the **RANGE SHIFT** softkey.
3. Select your desired setting using the trackpad.
4. Press **OK**.

To return to the standard fishfinder image

1. Press the **RANGE** softkey to select **AUTO**.
2. Press **OK**.

6.6 Presentation options

The **PRESENTATION** softkey gives you access to VRM features (for measuring depth and distance), frequency view selection and a scroll control. These settings affect the monitor you are working on.

Gain and power

The gain settings alter the way the fishfinder processes background noise (also called clutter). Use of these settings can improve the fishfinder readout.

For optimum performance, use the auto settings.

Gain settings

To adjust gain settings:

1. Press the **PRESENTATION** softkey.
2. Press the **GAIN** softkey
3. Select from the appropriate options on the toolbar.

You can adjust the following aspects of the gain:

- **Gain**
- **Color Gain**
- **TVG**
- **Color Threshold**

Gain

The gain adjusts the return threshold, above which the fishfinder will show an object on the screen

Auto Settings:

- **Low** (the default setting) is ideal for viewing fishfinder images with a minimum of background noise while you cruise to your fishing spot. Only the strongest echoes are displayed.
- **Medium** is a slightly higher gain setting that displays more detail.
- **High** provides the most detail, but also displays the most background noise and surface clutter.

Manual setting:

- Use the slider to set your required gain value.

Gain should be set high enough to see fish and bottom detail but without too much background noise. Generally, high gain is better in deep or clear water; low gain is better for shallow or murky water. The default setting for manual gain is 75%.

Color Gain

This sets the lower limit for the strongest echo color. All echoes with a signal strength above this value are displayed in the strongest color. Those with a weaker value are divided equally between the remaining colors. Setting a low value produces a wide band for the weakest color, but a small signal band for the other colors; setting a high value gives a wide band for the strongest color, but a small signal band for the other colors.

TVG (Time Varied Gain)

The TVG (Time Varied Gain) reduces clutter by varying the gain throughout the water column. This function is useful for reducing the appearance of 'noise'.

Increasing the TVG value increases the maximum depth to which TVG is applied; decreasing it reduces the maximum depth. A low TVG value has little effect on gain in shallow water; a high value decreases the gain in shallow water so that only the strongest echoes are displayed.

Power setting

The power setting controls the power level of the transducer.

To adjust power settings:

1. Press the **PRESENTATION** softkey.
2. Select from the appropriate **POWER** options on the toolbar.
3. In manual mode, use the trackpad to choose the power setting you want to use.
4. Press **OK**.

Power settings:

- **Auto**
This is the default setting. When it is selected the DSM automatically determines the required power setting based on the current depth, speed, and (bottom) signal strength.
- **Manual**
If you wish to manually adjust the power to suit current conditions, you can adjust the power level between 0% and 100%, in 10% increments. Lower power levels are normally used in depth ranges less than 8 ft. (2.4 m) and higher power levels are typically selected for depths greater than 12 ft. (3.7 m).

Dual / Single frequency view

Dual frequency operation allows the sonar to operate and display 2 frequencies simultaneously.

If the preset you are using has two frequencies, you can view either one or both of those frequencies in separate windows.

To set frequency views

1. Press the **PRESENTATION** softkey.
2. Toggle to **F1**, **F2** or **BOTH** on the **VIEW** softkey.
3. Press **OK**.

To configure your transducer for dual frequency

1. With a fishfinder window active, press and hold the **PAGE/MENU** button.
2. Select **Configure Frequency Presets**.
3. Use the trackpad to assign the required preset frequencies

Note: The **DUAL** preset has dual frequency values as a default setting.

See [Configure Preset Frequency settings on page 85](#) for more information on assigning frequencies.

Measuring depth and distance

The fishfinder display gives you various methods of measuring depth and distance:

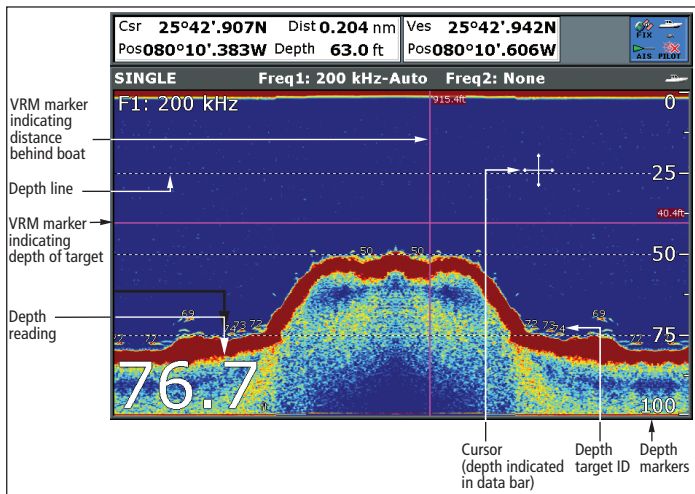

- **Depth reading** - your current depth. The size and position of this readout can be changed in the Fishfinder display Setup menu (see [page 85](#)).
- **Depth lines** - horizontal dashed lines drawn at regular intervals to indicate the depth from the surface. These are switched on/off in the Fishfinder Display Setup menu (see [page 85](#)).
- **Depth Target ID** - depths noted against recognized targets. The sensitivity of these IDs is directly linked to the Fish Alarm sensitivity; the greater the fish alarm sensitivity, the greater the number of labelled returns. These targets are switched on/off in the Fishfinder Display Setup menu (see [page 85](#)).
- **Cursor depth** - the depth and the distance from your boat

marked by the cursor, is indicated in the data bar at the top of the screen. This performs in a similar way to a VRM, but without lines.

- **VRMs** - to indicate the distance behind your boat and the depth below of selected objects.

Note: When multiple fishfinder windows are open, we recommend you have the depth reading displayed in at least one window.

Measuring depth and distance with VRM

You can use a Variable Range Marker (VRM) to determine the depth and distance-behind-boat of an object. These markers consist of a horizontal (depth) line and a vertical (distance-behind-boat) line; each of which are marked with the appropriate measurement and are controlled individually.

To make a measurement using VRM

1. Press the **PRESENTATION** softkey.
2. Press the **VRM** softkey.
3. Toggle to **ON**.
4. Pause the display to make it easier to position the VRM over the object.
5. Take your measurements:

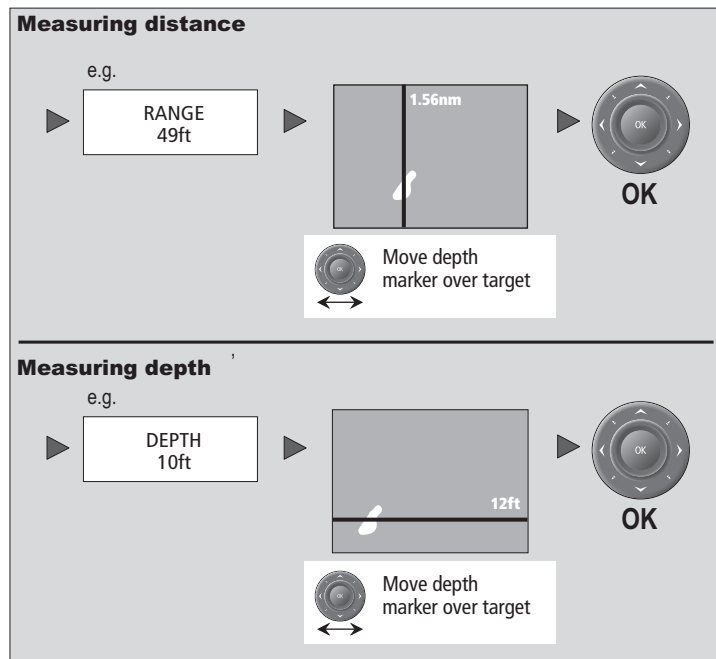

To return the marker to its previous position, press **CANCEL**.

Adjusting the scroll mode and speed

Scroll speed

You can adjust the speed at which the display scrolls, but the same section of the bottom is displayed regardless of scrolling speed. A faster speed displays more detail. This is useful when you are looking for fish. If you select a slower speed the information remains on the display for longer.

The following options are available:

- **Manual** - This allows you to set the scroll speed as a percentage of the maximum scroll rate for that depth. The lower the percentage, the slower the image will scroll. The default is manual adjustment with a full speed scroll (100%).

To select the scroll mode and speed

1. Open the **Fishfinder Setup Menu**.
2. Set your preferred values in the Manual Scroll Speed setting.

Pausing scroll

You can pause the display to see a 'snapshot' of the image. When a display is paused, scrolling stops but the depth indication continues to be updated. Scroll pause/resume affects the frequency showing on your display (both frequencies if two are selected) while other displays continue to scroll.

This allows you to inspect a paused image, place waypoints or VRMs, while the other frequency continues to scroll and detect fish.

To pause or resume scrolling

1. Press the **PRESENTATION** softkey.
2. Toggle settings on the **SCROLL** key.
3. Press **OK**

6.7 Placing waypoints

You can pause the scrolling image to place a waypoint at a position or target that you want to return to at a later date. When a waypoint is placed, its details are added to the Waypoint List and a vertical line labelled WPT is placed on screen. You can edit waypoints and navigate to them in an active fishfinder window.

To place a waypoint in Fishfinder mode

1. Press the **WPTS** button
2. Select the appropriate option:
 - **WAYPOINT AT CURSOR**
 - **WAYPOINT AT VESSEL**
 - **WAYPOINT AT LAT/LON**

For further information on waypoints operation refer to [Waypoints on page 30](#):

6.8 Fishfinder alarms

There are a number of alarm messages associated with the fishfinder application.

- **Fish Alarms** - sound when a target meets the specified sensitivity level and, is within the depth limits (if enabled). The greater the fish alarm sensitivity, the greater the number of target image depths displayed.
- **Shallow/Deep Alarms** - sound when the DSM detects that the depth is less than the shallow limit, or greater than the deep limit.

You can switch the alarms on, set the limits and specify the fish alarm sensitivity.

See also:

To configure that alarms refer to [Alarm Setup Menu on page 132](#).

6.9 Fishfinder Setup Menu

This section describes the settings you can change using the fishfinder setup menu. The setup menu contains settings that are likely to be changed infrequently.

For information on how to use setup menus, see [Setup menus on page 25](#).

To open the fishfinder setup menu

1. Make a fishfinder window active.
2. Press and hold the **PAGE/MENU** button.
3. Select **Fishfinder Setup**.

Configure Preset Frequency settings

Select frequencies for the 4 preset operating modes. Frequencies for your transducer are automatically detected by the system. You can:

- Specify one or two frequencies for each of the four presets.
- Edit preset names (EDIT NAME softkey).
- Reset all presets to factory defaults (RESET ALL softkey).
- Reset a selected preset to factory defaults (RESET <PRESET> softkey).

To open the Setup Frequency Preset screen

1. With a fishfinder window active, press and hold the **PAGE/MENU** button.
2. Select **Configure Frequency Presets**.

Manual frequency selection

If you select a frequency manually, the fishfinder operates at that fixed frequency.

The frequency affects readout on the fishfinder display by altering the penetration of the sonar signal

- **Lower frequencies** scan a wide area and penetrate water well. Use these settings if you want a large coverage beneath your boat or if you are in deep water.
- **Higher frequencies** (200 Khz) scan a narrow area but produce more detail, especially at high boat speed. They are most useful in shallower waters (up to 1000 feet).

Automatic frequency selection

The system will set and adjust the frequency automatically to suit your transducer and operating conditions.

Screen settings

The Fishfinder setup menu has a number of settings associated with the appearance of the Fishfinder screen.

To open the fishfinder setup menu

1. Make a fishfinder window active.
2. Press and hold the **PAGE/MENU** button.
3. Select **Fishfinder Setup**.

Option	Available settings
Depth digit size	Small Medium Large
Depth Digit Position	Top Bottom
TargetDepth ID Display depth readings for identified objects.	On Off
Depth Lines Horizontal lines indicating depth	On Off
White Line A white line along the contour of the sea bottom. This helps to distinguish objects close to the sea bed.	On Off
Bottom Fill Solid color fill for the sea bottom.	On Off
Color Palette	Night mode Plus a number of other palette options.
Manual Scroll speed	100% to 10%

Example display settings

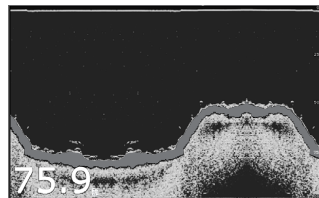

Standard fishfinder image

The standard fishfinder image displays the bottom as a combination of features (mud, sand, fish targets etc) with various sonar signal strengths.

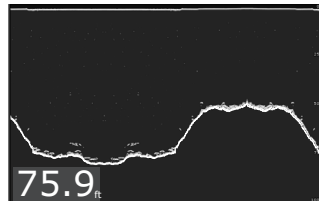

White line

When this feature is applied, a white line is drawn along the bottom (as defined by the digital depth value) and the detail below the bottom removed.

Fish near the bottom can now be seen more easily.

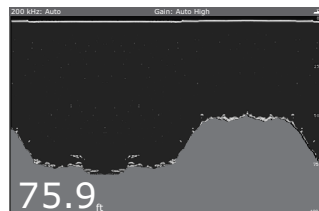

Bottom fill

When this feature is applied, the detail below the bottom is removed and replaced by a single contrasting color.

The bottom is now clearly defined and the fish near the bottom can be seen more easily.

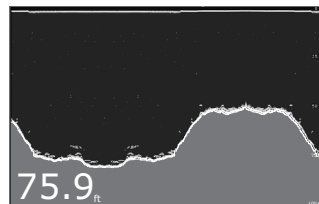

White line and bottom fill

When both White Line and Bottom Fill are applied, the bottom is defined by a white line and the detail below it replaced by a single contrasting color.

Both the bottom and fish near the bottom are now clearly defined.

Transducer settings

Nearby vessels equipped with a fishfinder, or certain physical conditions (like hard seabeds), can affect the DSM. Its setup menus enable you to change settings to allow for this.

Note: The setup options available depend upon the transducer fitted to your vessel.

Fishfinder settings should not ordinarily require adjustment.

To open the fishfinder transducer settings menu:

1. Make a fishfinder window active.
2. Press and hold the **PAGE/MENU** button.
3. Use the trackpad to select the **Transducer Settings** option.

Transducer options

- **Select Transducer**
When selecting a transducer, the A-Series displays a list of possibilities from which you can choose.
- **Select Speed Transducer**
This option is only available if the selected transducer is one that does not include an integrated speed transducer.
- **Frequency Calibration**
Hides the setup menu and brings up a set of soft keys to tune the transducer frequencies.
- **Depth Offset (waterline)**
Offset represents the depth of the transducer (relative to the waterline)
- **Speed and temperature offsets**
Calibrate the speed transducer and thermistor (if fitted).
- **DSM Reset**
Restores all settings to factory default.

- **Trip Counter Reset**
Zero the trip counter.
- **Interference Rejection**
Removes spikes caused by interference from other fishfinder-enabled vessels.
- **2nd Echo Interference Rejection**
Finely adjust the ping rate according to the 2nd echo level.
- **Ping Rate Limit (per sec)**
Provides a speed limiter. It can be useful to adjust ping rate to suit local conditions, for example when you are over a hard seabed or in shallow water.
- **Ping Enable**
Normally enabled, you can disable the ping when appropriate: to test other equipment, or if there is a diver beneath the vessel, for example.

Chapter 7: Sirius weather (US only)

7

Requires a Raymarine SR50 Sirius weather receiver.

With a Raymarine SR50 Sirius Weather Receiver installed in your boat's system and a suitable subscription purchased, historical, live and forecast weather can be superimposed onto a world map. This can be used to check the weather for your current position or areas that you are planning to visit.

This chapter should be read in conjunction with your Sirius Weather Receiver handbook:

Chapter contents

- [7.1 System requirements on page 89](#)
- [7.2 Using Sirius Weather on page 89](#)
- [7.3 Animated weather graphics on page 95](#)
- [7.4 Viewing weather reports on page 96](#)
- [7.5 Troubleshooting on page 97](#)
- [7.6 Weather application setup on page 97](#)

See also

- Disclaimer
For disclaimer see [page 151](#).

7.1 System requirements

Before you can use the weather application you need to:

- Obtain a Sirius ID number. (For full details, see the Sirius Installation handbook.)
- Customize a page set to include a weather application.
- Specify the weather elements that you wish to display.
- For the A-Series to display weather data, it must be connected to an SR50 Sirius Receiver which is supplying the appropriate data.
- For your vessel to be displayed and for weather reports to be available at your position, you need a fix for your boat's position and be within range of Sirius satellites.

For further information on installing and commissioning a weather receiver, see the SR50 Weather Receiver Installation Guide.

7.2 Using Sirius Weather

Creating a weather page

A weather application window is not included in the pre-configured page sets. You therefore need to customize a page set to include one. For information about how to do that, see [Page sets on page 127](#).

The weather display

The main features of the weather display are shown below.

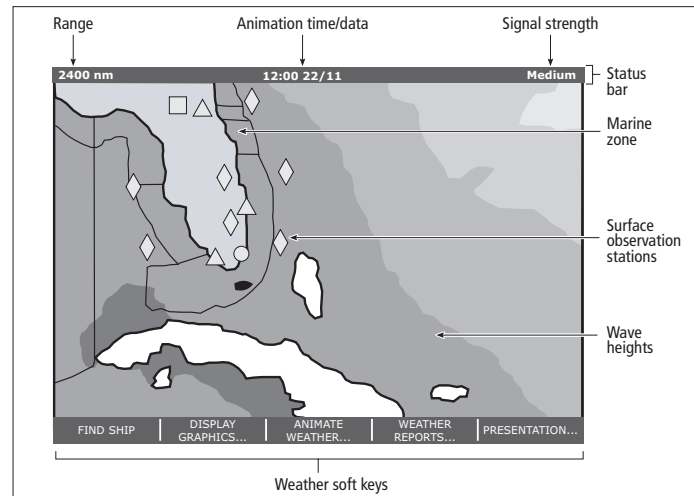

Note: Time shown can be either for the time of latest data or animation time/date, as appropriate.

Specifying meteorological elements

You can choose to view textual weather reports or animated graphics for specific weather element.

To specify meteorological elements

1. Make a weather window active.
2. Press the **DISPLAY GRAPHICS** softkey.
3. Select a weather element and make the appropriate setting for each element you are interested in.
4. Press **OK**.

Moving around the weather map

When you open the weather application, a world map is displayed. Use the cursor to move around the map and the range button to zoom in and out.

To re-centre the map on your boat, use the **FIND SHIP** softkey.

Placing waypoints

The waypoint button operates as normal when a weather window is active, but you need to make the chart window active to see any waypoints created.

Weather symbols

The system has a number of symbols to describe aspects of the weather

Many symbols have additional data associated with them. If this is the case, the object window will contain the text "OK for more info".

To display additional data for meteorological objects

1. Highlight the object.
2. If a pop-up indicates that additional data is available, press **OK** to see it.

Weather symbols

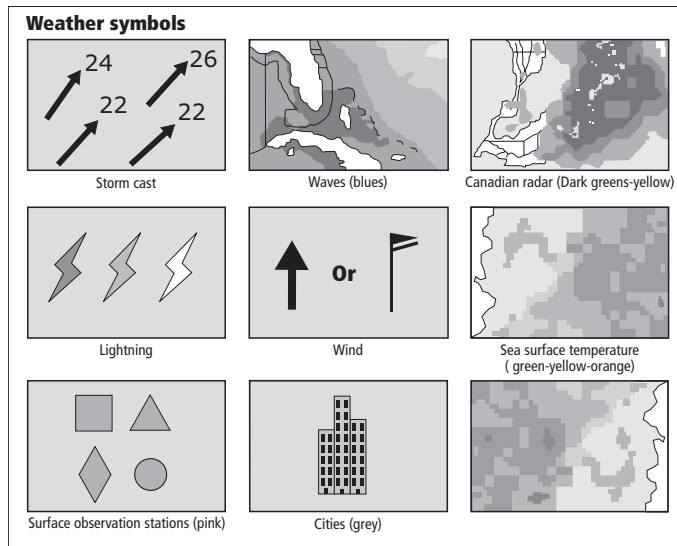

Storm track symbols

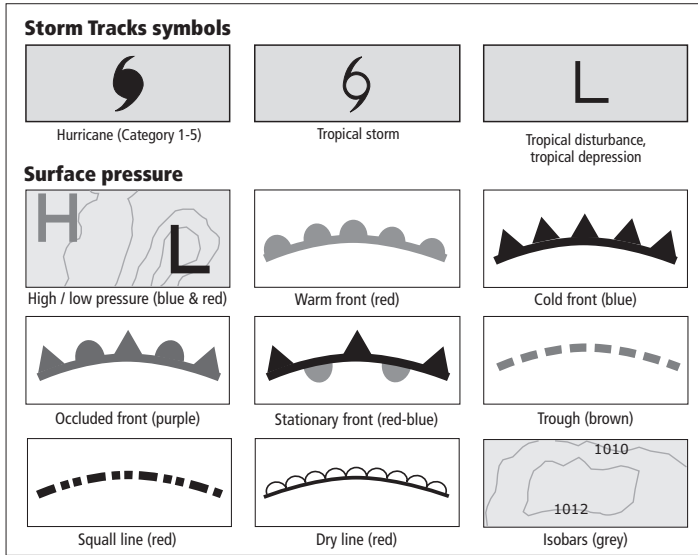

Precipitation (NOWRad)

NOWRad displays the type and level of precipitation:

Color	Precipitation type	Intensity (dBz)
Light green	Rain	15-19
Medium green	Rain	20-29
Dark green	Rain	30-39

Color	Precipitation type	Intensity (dBz)
Yellow	Rain	40-44
Orange	Rain	45-49
Light red	Rain	50-54
Dark red	Rain	55 +
Light blue	Snow	5-19
Dark blue	Snow	20 +
Light pink	Mixed	5-19
Dark pink	Mixed	20 +

Storm Cast

Storm cast arrows indicate the direction and speed of a storm.

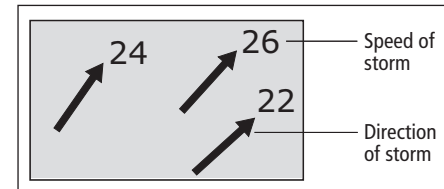

Sea surface temperature (SST)

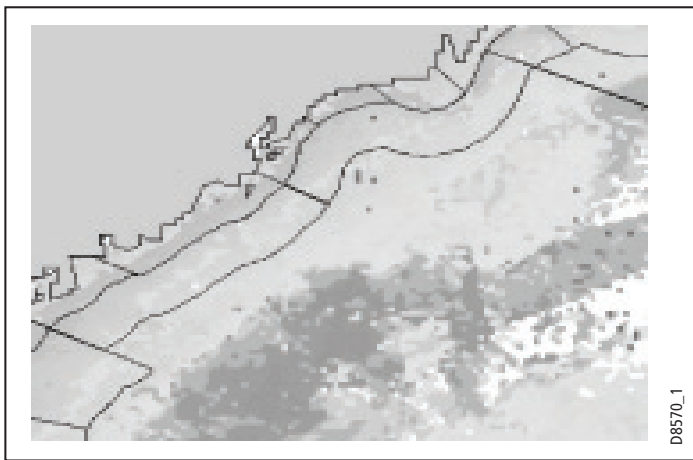

The temperature range of the sea surface is indicated by shading, from low temperatures to higher temperatures through blue-green-yellow-orange-red.

Canadian radar

Canadian radar shows the intensity of precipitation for Canada. Unlike NOWRad, Canadian radar does not show the precipitation type.

Color	Intensity (mm/hr)
Transparent	0.00-0.20
Light green	0.21-1.00

Color	Intensity (mm/hr)
Medium green	1.01-4.00
Dark green	4.01-12.00
Yellow	12.01-24.00
Orange	24.01-50.00
Light red	50.01-100
Dark red	100.01 +

Tracking storms

You can use the STORM TRACK function to monitor significant storms in your area. These include tropical disturbances, depressions, storms and cyclones, hurricanes, typhoons and super-typhoons.

The display shows the path the storm has taken, its current and forecast position, the wind radii (for its current position only), and its current direction and speed of travel.

Storm Tracks symbols

These symbols are displayed on screen in three different colours: Grey - historical, Red - current, Orange - forecast



Hurricane
(Category 1-5)



Tropical storm



Tropical disturbance,
tropical depression

Move the cursor over the symbol for additional information.

D8570_1

Tropical storm data

Tropical storm data can be displayed for a selected storm. The data includes:

- The storm's name, type, date and time.
- The position, direction and speed of travel of the storm.
- The pressure and maximum wind speed and gusts.

Lightning

The system puts a lightning symbol at every cloud-to-ground strike recorded within the last 5, 10 and 15 minutes.

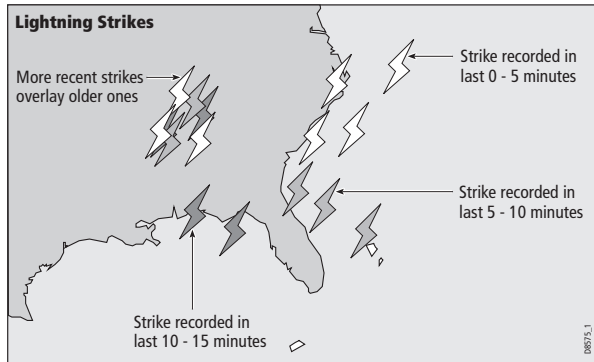

Surface observation stations

You can view current or historical weather data at surface observation stations.

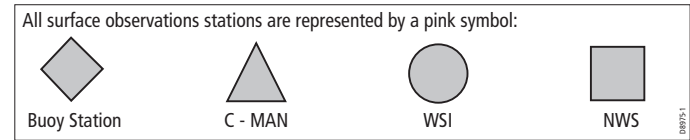

City forecasts

The Cities option gives you access to details of city weather forecasts. Forecasts for up to three days may be available.

Wind

This option displays the current wind direction and magnitude. You can choose (using the Weather Setup Menu) to display the wind symbol as either an arrow or a wind barb. Wind arrows give an indication of wind speed - the larger the arrow the stronger the wind.

Wind barbs give a more precise representation of wind speed:

Example Drg

Wind speed symbols

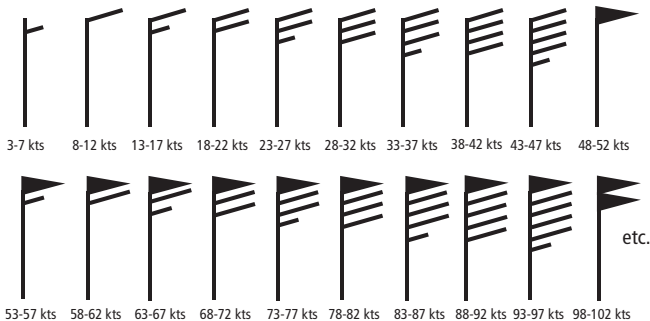

Waves

This option gives you wave period, wave direction and wave height data.

Wave height is displayed in 16 levels:

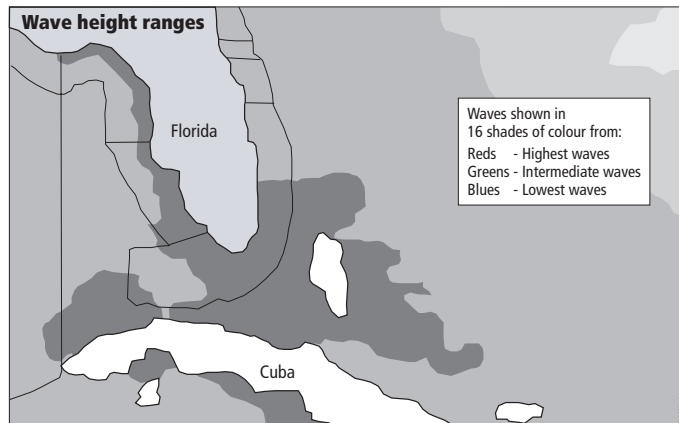

Surface pressure

This option shows surface pressure data using standard meteorological symbols.

Example Drg

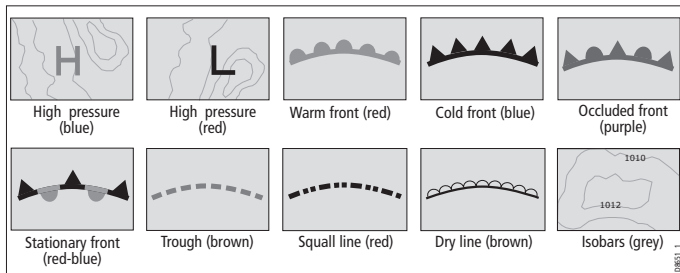

Viewing data for a specific position

It is possible to display the sea temperature, wind speed and direction, wave height, precipitation intensity and type for a location specified by you. The marine zone is also shown.

To view data for a specific position

1. Move the cursor to the required position.
2. Press **OK**.

7.3 Animated weather graphics

The animated weather feature allows you to view an animation from the current time for:

- The forecast for wind and wave activity or surface pressure.
- The weather radar history loop (NOWRad).

You cannot display information by moving the cursor over a symbol when animation is running.

The range and trackpad controls do however remain operable, provided the PAUSE option has not been selected. Ranging or panning causes the animation to restart.

The animation stops if you press any of the ACTIVE, PAGE, DATA, WPS/MOB, or PAGE/MENU buttons, or if you close the window containing the animation.

To set up an animated weather graphic

1. Press the **ANIMATE WEATHER** softkey.
2. Toggle to the required setting on the **ANIMATE TYPE** softkey.
3. Toggle to the required option on the **FORECAST** softkey (wind, wave or surface pressure).

To run an animation

1. Press the **ANIMATE WEATHER** softkey.
2. Toggle to **ON** with the **ANIMATE** softkey.

The status bar indicates the time-frame displayed. The weather radar history provides up to eight images of data covering the last two hours, at 15-minute intervals.

To pause an animation

1. Press the **PAUSE** softkey.

7.4 Viewing weather reports

The following weather reports are available:

- Tropical statements.
- Marine warnings.
- Marine zone forecasts.
- Watchbox warnings.

Each report type may contain several bulletins; the window can be scrolled to view all the data.

To view weather reports

1. Press the **WEATHER REPORTS** softkey.
2. Press the appropriate softkey for the type of report you want.

If available, select the relevant option on the **FORECAST AT** softkey (ship or cursor).

Watchbox warnings

When a tornado or thunderstorm warning is received, the system generates a watchbox alert:

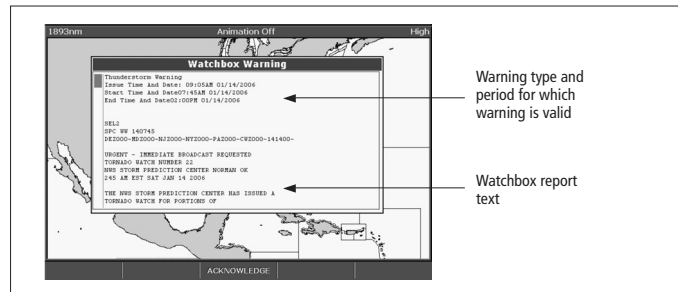

Use the trackpad to scroll through the report.

You can set the range for the watchbox alert to: OFF; 50; 150; 300; 500 and ALL using the weather setup menu. Any watchbox outside of the selected range will not trigger the alarm. (Units vary according to the configuration of your system.)

You can switch off the marine watchbox alert (using the Weather Setup Menu, see [page 98](#)) or set the watchbox status to hide. Reports continue to be added to the database, irrespective of the alert and show/hide status.

To clear a watchbox alert

1. Press **ACKNOWLEDGE**.

The alert is removed from the display but you can still see the watchbox warning by using the Weather Reports softkeys.

Displaying marine watchboxes

When the marine watchboxes feature is ON (default), any regions for which a watchbox is valid are highlighted on the weather map as a red polygon.

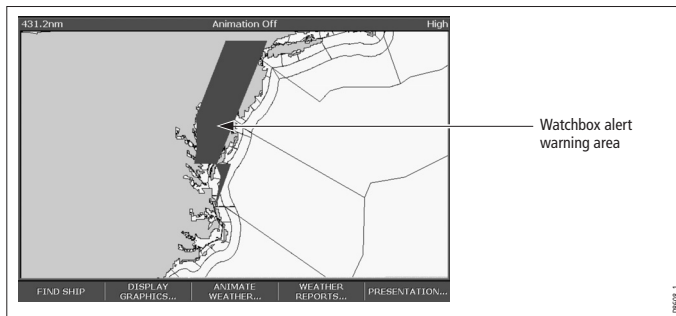

To show or hide watchboxes

1. Press the **PRESENTATION** softkey.
2. Toggle to the appropriate setting on the **WATCHBOX** softkey.

To display watchbox data

1. Highlight the watchbox.
2. Press **OK** to display the Object Info pop-up screen.
3. Press **OK** again to display the watchbox data.

7.5 Troubleshooting

Problem	Reason
Boat symbol not displayed	No position fix
FIND SHIP softkey greyed-out	No position fix
Boat symbol drawn as a solid circle	No heading or COG available
'No Connection' message is displayed in the status bar	No signal received from SR50; check cabling and that SR50 is powered.

7.6 Weather application setup

With a weather window active, the Weather Setup Menu is available from the system Setup menu.

To open the Weather Setup Menu

1. With a weather window active, press and hold the **PAGE/MENU** button.

2. Select **Weather Setup** menu.

FUNCTION	OPTION
Sirius Weather User ID Details the Weather ID obtained from Sirius and keyed in on your display.	(as advised)
Wind Symbol Graphic used for wind symbol	Arrow Barb
Marine Watchbox Alerts Enables alert when watchbox is issued.	OFF 50nm 150nm 300nm 500nm ALL

Chapter 8: Sirius Audio (US only)

Requires a Raymarine SR50 Sirius weather receiver.

If you have a Sirius SR50 data receiver installed, you can use the A-Series system to control satellite radio broadcasts.

Refer to the SR50 documentation for installation information.

Chapter contents

- [8.1 Using Sirius Radio on page 101](#)
- [8.2 Parental locking on page 104](#)
- [8.3 Favourite song alerts on page 104](#)

8.1 Using Sirius Radio

To start using Sirius radio

1. Press and hold the **PAGE/MENU** button.
2. Select **Sirius Satellite Radio** from the options displayed.

The Sirius Radio Control screen opens:

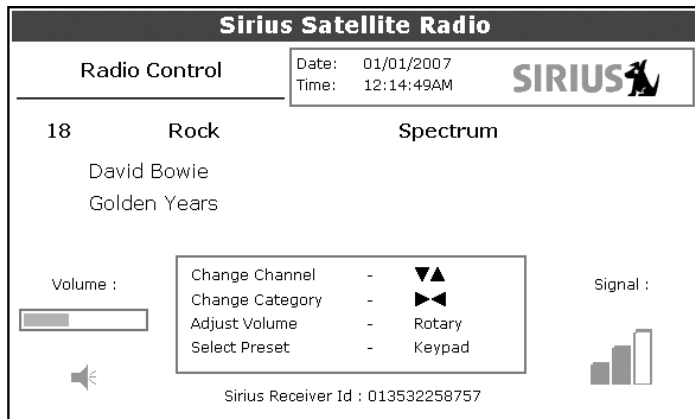

Information contained on the Sirius Radio Control screen includes:

- Current channel name, number and category
- Play data for the current channel
- Date and time
- Receiver ID and signal strength

Use the softkeys and trackpad to control audio functions.

The toolbar gives you access to the functions outlined below.

MUTE ON/OFF	Controls the mute setting.
PRESETS	Displays a list of preset channels and the full channel list with modify options. Use the trackpad to scroll through the list of presets.
SETUP CHANNELS	Gives access to the Edit Presets, Edit Alerts, Edit Channel Access, Scan Channels softkeys.
ALERTS	Lets you set up an alert to tell you when favourite songs or artists are played on any channel.
BROWSE	Scroll to view play data and to select channels, presets, or categories.

Tuning to a channel

From the Sirius Control screen, you tune to channels using the trackpad or the alphanumeric keys.

Trackpad up	Next channel.
Trackpad down	Previous channel.

Trackpad left	First channel in the previous category.
Trackpad right	First channel in the next category.

Browsing channels

The browse function allows you to view play data for channels without tuning to them.

To browse channels

1. On the Sirius Audio Control screen, press the **BROWSE** softkey. Pressing this key displays the Channel List or Preset List for browsing. Toggle between the two lists with the **VIEW ALL/PRE** softkey.
2. Use the trackpad to scroll through the channels.
3. Press the **TUNE TO CHANNEL** softkey to listen to the selected channel.
4. Press **OK**. to go back to the Sirius Control screen.

Filtering categories from the browse

This feature allows you to choose a category from which to browse channels; other categories are excluded from the browse.

To filter categories

1. On the Browse screen, press the **FILTER BY** softkey.
2. Press the **SELECT CATEGORY** softkey.
3. Using the trackpad, select the category you want to browse.
4. Press **OK**.

Scanning channels

The Scan function automatically tunes to all channels in turn.

To scan channels

1. Press the **SETUP CHANNELS** softkey.
2. Select **SCAN CHANNELS**.
3. Use the **SCAN ALL/PRE** softkey to choose to scan all channels or only preset channels.
4. Press **SELECT** to stop the scan and listen to the active channel.

Hiding or showing channels and categories

You can select particular channels and categories to be excluded (hidden) from the Browse and Scan sequences.

To hide or show a channel or category

1. Press the **SETUP CHANNELS** softkey.
2. Select **EDIT CHANNEL ACCESS**.
3. In the channel list, select the channel you want to hide. If you want to hide a category, select any channel in that category.
4. Toggle between hidden and shown states with either the **CHANNEL SHOWN/HIDDEN** or **CATEGORY SHOWN/HIDDEN** softkeys.

Presets

You can assign up to 18 channels to presets to make tuning, scanning and browsing easier. To assign a channel to a preset, use the **PRESETS** softkey from the main control screen or the **EDIT PRESETS** softkey from either of the following screens:

- Setup channels
- Browse channels

At the Edit Preset Channels screen you can select a preset and assign a channel to it, move the assigned channel to a different preset, or delete the assigned channel.

Toggle between the Preset Channels list and the Channel List either by using the trackpad (left/right) or by pressing the appropriate softkey.

To assign a channel to a preset

1. Select an unused preset number from the Preset List.
2. Press the **ASSIGN NEW CHANNEL** softkey.
3. Select the target channel from the Channel List.
4. Press the **ASSIGN TO PRESET** softkey.

Note: If the preset you want to use already has a channel assigned to it, delete the preset first.

To delete a channel from a preset

1. In the Preset Channels list, select the preset you want to clear.
2. Press the **DELETE CHANNEL** softkey.

To move a channel to a new preset

1. Use the trackpad to select the preset you want to move.
2. Press **MOVE TO NEW PRESET**.
3. Scroll to the preset you want to move the channel to.

4. Press **MOVE TO NEW PRESET**.

Note: You can overwrite a channel that has already been assigned to a preset, but you will be prompted to confirm the action.

8.2 Parental locking

You can set up blocks on selected channels so that they can only be played if a correct password is entered. Parental locking must be enabled for the blocks on your selected channels to be effective.

By default, blocking is not enabled.

To enable blocking

1. Press the **SETUP CHANNELS** softkey.
2. Press the **PARENTAL LOCK ON/OFF** softkey so that **ON** is highlighted.

To set up a password

1. Press the **SETUP CHANNELS** softkey.
2. Press the **PARENTAL LOCK** softkey to highlight **ON**.
3. At the Password Setup screen, enter and confirm your password and hint.

You can also access the password entry screen by pressing **EDIT CHANNEL ACCESS** then **CHANNEL ENABLED/LOCKED**.

To change an existing password

1. Press the **EDIT CHANNEL ACCESS** softkey.
2. Press the **EDIT LOCKOUT PASSWORD** softkey.
3. Enter your old password, then the new password and hint.

To block a channel

1. Press the **SETUP CHANNELS** softkey.
2. Press the **EDIT CHANNEL ACCESS** softkey.
3. In the Channel List, select the channel you want to block.
4. Press the **CHANNEL ENABLED/LOCKED** to highlight **LOCKED**.

5. Repeat steps 3-4 for each additional channel you want to block.
6. When you have blocked all the channels you want, press the **CLEAR** key.
7. Ensure the parental lock is on (**ON** is highlighted on the **PARENTAL LOCK ON/OFF** softkey).
8. At the prompt, enter your password.

Blocked channels remain visible in channel lists, but you cannot select them with the trackpad and they are ignored by the scan function. They are marked as locked by an icon next to the channel name.

Entering passwords

If you select a blocked channel from the channel list or want to block a channel when the parental lock is on, you will be asked to enter the password.

After three incorrect attempts, the system displays your password hint.

8.3 Favourite song alerts

The favorites feature alerts you when a favourite song or artist is playing on any channel. You can define up to ten favorites using the Alerts softkey.

To enable favourite alerts

1. Press the **ALERTS** softkey to open the Edit Alerts screen.
2. Use the **ALERTS ON/OFF** softkey to toggle favourite alerts on and off.

To set up a song or artist alert

- Press the **ALERTS** softkey to open the Edit Alerts screen. This screen shows ten favorites and the song playing currently.
- You can delete a favourite from the list, add the current song or artist to the list or switch the favorites alert off.
- You can also mark a channel or song as a favourite by pressing the **ASSIGN TO ALERT** softkey while scanning.

When alerts are turned on and the system detects one of your favorites being played on any channel, it will display an alert and sound the alarm.

To tune to the channel playing the song, press **TUNE TO CHANNEL**. To ignore the alert, press **CLEAR ALERT**.

Chapter 9: Navtex

With a suitable Navtex integrated receiver connected to your A-Series Display you are able to receive and show marine safety information including weather forecasts and marine warnings.

Major areas of coverage include the Mediterranean Sea, The North Sea, coastal areas around Japan and areas around the North American continent.

This chapter should be read in conjunction with your Navtex receiver handbook.

Chapter contents

- [9.1 Setting up Navtex on page 107](#)
- [9.2 Selecting message alert categories on page 107](#)
- [9.3 The Navtex message window on page 107](#)
- [9.4 Managing Navtex messages on page 108](#)

9.1 Setting up Navtex

Before you are able to view Navtex messages you need to enable Navtex by setting the NMEA port appropriately.

To enable Navtex

1. Press and hold the **PAGE/MENU** button to open the setup menu
2. Use the Trackpad to select the **System setup** menu
3. Scroll down to and select the **System Integration** menu
4. Select the **NMEA Port Setting**
5. Choose the appropriate Navtex setting to suit your receiver.

9.2 Selecting message alert categories

On initial power up, the system provides alerts for all message categories listed in the Navtex Alert Menu. You can switch off any category except Navigation Warnings (Category A), Meteorological Warnings (Category B) and Search and Rescue information (Category D).

To select the message alert categories

1. Press and hold **PAGE/MENU** to open the Setup menu.
2. Select **Navtex Messages** and open the **Navtex Message List**.
3. Press the **SETUP ALERTS** softkey.
4. Select the appropriate category and toggle its status to the required setting.

9.3 The Navtex message window

Once correctly connected to the Navtex unit, the system will display messages it receives from within your chosen categories:

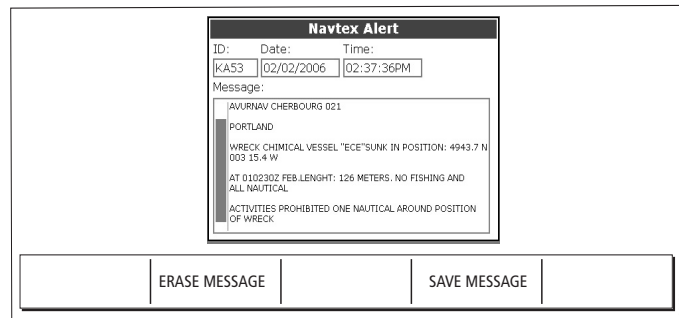

When you receive a message, the toolbar gives you the option to erase or save the message as appropriate. The A-Series can save up to 100 Navtex messages. Once this capacity is reached, it starts to overwrite the oldest messages with newer ones.

To view saved messages

1. Press and hold **PAGE/MENU** to open the Setup menu.
2. Select **Navtex messages**.
3. Select the appropriate message from the list.

The message text is displayed in the right-hand column. Scroll through it to see the complete text.

You also have the option to sort the message list by date, station or category, erase a message, or set up the message alerts.

9.4 Managing Navtex messages

Management options for Navtex messages allow you to:

- Select categories for which the A-Series will show alerts.
- Erase messages.
- Sort the message list.

Sorting the message list

By default the message list sorts by the date and time the message was received (DATE) with the most recent message at the top. If required, you can sort the list by station identifier (STN) or by message category (CAT).

To sort the message list

1. Press and hold **PAGE/MENU** to open the Setup menu.
1. Select **Navtex Messages** and open the **Navtex Message List**.
2. Toggle to your preferred sorting method on the **SORT LIST** softkey.

Chapter 10: AIS

Requires a compatible AIS receiver and VHF radio.

With your A-Series Display connected to a suitable Automatic Identification System (AIS) receiver you will be able to access information broadcast between other suitability equipped boats and shore based stations. This information is used to provide fast, automatic and accurate hazard awareness and collision avoidance data.

This chapter should be read in conjunction with your AIS receiver handbook.

Chapter contents

- [10.1 Background information on page 111](#)
- [10.2 Setting up AIS on page 112](#)
- [10.3 Using AIS on page 112](#)
- [10.4 Safe zones on page 114](#)
- [10.5 AIS display options on page 115](#)
- [10.6 Messages and alarms on page 117](#)
- [10.7 AIS alarms on page 117](#)

10.1 Background information

AIS broadcasts information between vessels and shore-based stations on VHF frequencies in the maritime band. This information is used to provide fast, automatic and accurate collision-avoidance data. It can operate in radar blind spots and can detect smaller (AIS-equipped) vessels than radar can.

AIS does not replace radar, because it is unable to detect land or navigation beacons.

Classes of AIS data

AIS data is defined as Class A or Class B. The sending and receiving of Class A data is compulsory for larger vessels. You will therefore be able to view all larger vessels on your AIS display.

Not all AIS receivers will decode all information and not all of the Class A vessels input all of the required AIS data. For example, some inexpensive AIS Class B receivers do not decode and output the ship's name, IMO number and vessel data.

Class B data is applicable to smaller vessels and is not compulsory. Do not assume that your AIS will display data for all smaller vessels in your area.

The following information can be transmitted by a Class A AIS system:

- **Static data:** ship name, type, MMSI number, call sign, IMO number, length, beam and GPS antenna location.
- **Voyage data:** draft, cargo, destination, ETA, other relevant information.
- **Dynamic data:** time, position, COG, SOG, gyro heading, rate of turn, navigational status.
- **Dynamic reports:** speed and status.
- **Messages:** alarm and safety.

10.2 Setting up AIS

Before you are able to view AIS targets you need to set up the NMEA port appropriately.

To enable AIS

1. Press and hold the **PAGE/MENU** button to open the setup menu
2. Use the Trackpad to select the **System setup** menu
3. Scroll down to and select the **System Integration** menu
4. Select the **NMEA** Port Setting
5. Choose the appropriate setting.
6. Press **OK**

10.3 Using AIS

AIS is a selectable layer of the chart application.

To switch AIS layer on

1. With a chart window active, press the **PRESENTATION** softkey.
2. Press the **CHART LAYERS AND DATA** then the **CHART LAYERS** softkeys
3. Use the trackpad to turn **ON** the **AIS Objects** option.

AIS status icons

Status icons are displayed in the data bar.



No recent AIS messages. (Also displayed if there is no GPS fix)



There are recent AIS messages.



AIS unit on with active alarms.



AIS unit switched on and operating but dangerous and lost alarm disabled.

AIS Layer

The AIS Layer Setup Menu allows you to:

- Select target types displayed (ALL or DANGEROUS).
- Switch AIS safety messages on or off.
- View the list of active AIS alarms.

To display the AIS Layer Setup Menu

1. Ensure the **AIS LAYER** is set to **ON** (see [Using AIS on page 112](#)).
2. Press and hold the **PAGE/MENU** button.
3. Select **AIS Layer Setup**.

The AIS screen

Suitably AIS-enabled vessels (or AIS ‘targets’) appear as triangular symbols. Up to 100 targets can be displayed.

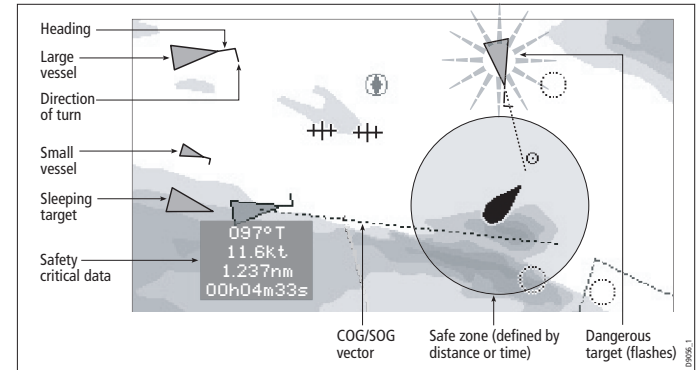





Vectors can be displayed for each target. These vectors indicate the direction of travel and rate of turn of the vessel and the distance it will travel over a specified period of time (COG/SOG vector). Targets displayed with their vectors are referred to as ‘active targets’ and are scaled according to the size of the vessel.

You can choose to display all targets or just the dangerous ones (see [page 113](#)).

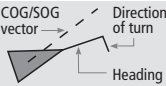
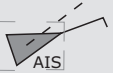
AIS Target symbols

AIS target symbols are summarized below.

Sleeping target <ul style="list-style-type: none">• Target not activated, dangerous or lost.	
Activated target <ul style="list-style-type: none">• Target activated i.e. AIS vector displayed.• Vector line (optional) shows predicted distance travelled within given time.	
Selected target <ul style="list-style-type: none">• Target selected with cursor.• Can activate the target and view detailed data.	
Dangerous target <ul style="list-style-type: none">• Targets within specified distance (CPA) or time (TCPA).• Dangerous target alarm sounds if enabled.• Target flashes.	
Uncertain target <ul style="list-style-type: none">• Calculated CPA/TCPA value uncertain.	
Lost target <ul style="list-style-type: none">• When signal of dangerous target not received for 20 seconds.• Target in latest predicted position.• Alarms sounds if enabled.• Target flashes.	

08523-1

Viewing AIS information

You can display information relating to individual AIS targets.

To see AIS data for a selected target

1. Highlight the AIS target with the cursor.
2. Select the appropriate data from the toolbar.

10.4 Safe zones

A safe zone is a circular area created about your boat. If an AIS target (i.e. a vessel transmitting AIS data) enters this area, your A-Series will consider it as dangerous and sound an appropriate alarm. The perimeter of the safe zone appears on-screen as a red ring around your vessel icon.

The system controls the safe zone and considers a target dangerous if it comes within the specified perimeter of the safe zone using the following criteria:

- CPA.
- TCPA.

When the system recognizes a dangerous AIS target:

- The target symbol changes to red and flashes.
- An on-screen warning is shown.
- An alarm sounds (if enabled in the setup menu).

To set up an AIS safe zone:

1. Press the **TARGET TRACKING** soft key.
2. Press the **AIS OPTIONS** soft key. The AIS options dialog box appears.
3. Select the Own Vessel Safe Zone and set the radius of your boat's safe zone.

Safe zone alarm

The safe zone alarm is an audible warning that sounds when a target enters your vessel's safe zone and becomes dangerous.

The safe zone alarm will sound irrespective of a target's status, display or the safe zone status. The current status of AIS alarms is shown by the AIS icon in the data bar.

Time to safe zone

The time to safe zone feature calculates how long it will take other AIS equipped vessels to reach your safe zone, based on their AIS data.

To set the time to safe zone:

1. Press the **TARGET TRACKING** soft key.
2. Press the AIS OPTIONS soft key. The AIS options dialog box appears.
3. Select Time to Safe Zone and set the required time.
4. Press **OK**.

10.5 AIS display options

Displaying AIS vectors

The AIS vector feature gives you the following data for selected targets:

- A COG/SOG vector indicating the predicted distance that a target will travel within a given period of time.
- Graphical representation of heading and direction of turn.

To switch AIS vectors on or off

1. Highlight the AIS target for which you want to display vectors.
2. Toggle to your desired setting on the **AIS VECTOR** softkey.

Displaying safety-critical AIS data

Safety-critical target data such as COG, SOG, CPA and TCPA can be displayed in the tag alongside each target. You can switch this data on or off or set it to display it automatically when the cursor is over the target.

To view AIS data

1. Highlight an AIS target.
2. Toggle to your preferred setting on the **AIS DATA** softkey:

AUTO (default): safety-critical data shown when the cursor is over the target.

ON: safety-critical data shown constantly.

OFF: safety-critical data never shown.

AIS list

The AIS list provides collision-avoidance data for the highlighted target:

AIS Target List			
No.	Name/MMSI	Rng	Brg
1	Sim Target 12	7.231nm	1.9°S
2	Sim Target 17	7.684nm	78.1°P
3	Sim Target 6	9.619nm	24.8°P
4	Sim Target 1	10.43nm	125.7°P
5	Sim Target 18	11.59nm	16.8°P
6	Sim Target 9	12.27nm	47.6°S

MMSI	12	Position	50°35'.985N
Last seen	01/01/2004		001°11'.536W
	12:52:55AM	Heading	208°T
Vessel	-----	ROT	+000°/min S
		COG	221°T
		SOG	16.9kt

To display the AIS List

1. Make a **chart window** active, with **AIS Layer** turned on.
1. Press the **AIS OPTION** softkey.
2. Press the **TARGET TRACKING** softkey.
3. Select **AIS LIST**.

Full AIS data

Full AIS data for an individual target includes static, dynamic and voyage related data.

To view full AIS data for a target

1. Highlight the target with the cursor.
2. Press the **VIEW FULL AIS DATA** softkey.

or

1. Select the target on the AIS list.
2. Press the **VIEW FULL AIS DATA** softkey.

AIS Options softkey

The **AIS OPTIONS** softkey provides a number of configuration settings.

Parameter	Options
Vector Length The time period specified for drawing length of vectors.	0.5min, 1 min, 3 min, 6min , 12min, 30 min, 60 min
Own vessel safe zone The safe zone is a ring, centred on your boat, within which a target is considered dangerous if it comes within a specified distance (CPA).	0.1 nm, 0.2nm, 0.5nm , 1.0 nm, 2.0nm
Time to safe zone If a target enters your safe zone within this time period, it is considered dangerous.	3 mins , 6 mins, 12 mins, 24 mins
Safe zone ring Controls whether the safe zone ring is displayed or hidden on screen	Visible Hidden

10.6 Messages and alarms

Safety messages

When AIS Safety Messages is on (controlled from the AIS Layer Setup Menu), incoming safety messages from vessels, shore stations and mobile stations are displayed in a pop-up box. The message will include latitude and longitude if it is available.

Whenever you receive a safety message, the system gives you options to:

- Remove the message (ACKNOWLEDGE).
- Place a waypoint to mark the sending vessel's position.
- GOTO the sending vessel's position.

Note: When the simulator is operating you will not be able to receive any safety messages.

10.7 AIS alarms

In addition to the dangerous target alarm, the system generates an alarm when a dangerous target becomes lost (this happens if the AIS signal from a tracked vessel is not received for more than 20 seconds).

When the connected AIS unit generates an alarm, the A-Series indicates the alarm status in the data bar and displays a warning message:

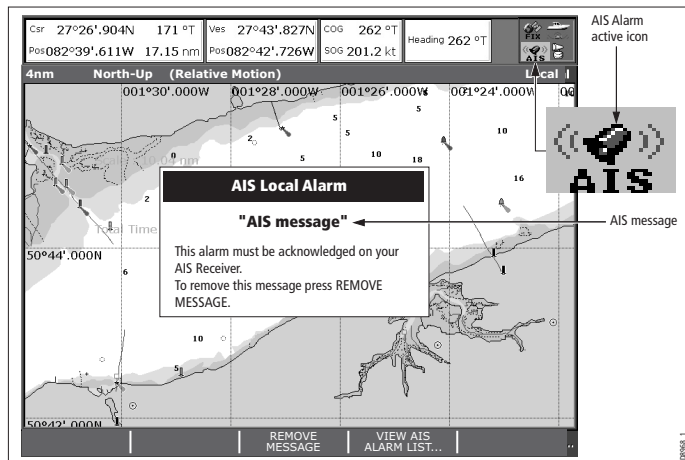

Active alarm list

The active alarm list shows the status of each local alarm. This list can either be accessed via the AIS Layer Setup Menu (see [page 113](#)) or from the Alarms Setup Menu (see [page 132](#)).

To acknowledge an AIS alarm

1. Press either the **REMOVE MESSAGE** or **VIEW AIS ALARM LIST** softkey.
2. Acknowledge the message at your AIS unit.

Note: Alarms remain active until they are acknowledged on the AIS unit. Removing the message or adding it to the Alarm list on your A-Series system does not cancel the alarm.

Chapter 11: Data and Engine monitors

11

The A-Series can display data from compatible equipment and engines connected to the NMEA and SeaTalk¹⁹ inputs.

Chapter contents

- [11.1 System requirements on page 121](#)
- [11.2 Data application on page 121](#)
- [11.3 Engine monitor on page 122](#)
- [11.4 Customizing data panels on page 124](#)

See also...

- www.raymarine.com for information about compatible engines and related software updates.
- For connection details refer to the separate installation guide.

11.1 System requirements

Engine requirements

- Compatible engines only. Your engine requires a NMEA 2000 interface. Check with your engine manufacturer for compatibility.
- Most engine types require a connecting cable from the engine manufacturer.

Data monitoring requirements

The A-Series requires suitable data sources, these can include

- Compatible Raymarine instruments
- Compatible engines
- Other equipment and instruments connected via NMEA0183 or SeaTalk^{ng}

11.2 Data application

The data application page is shown as a data panel. Each panel provides various data regarding your system and environment.

Ves Pos 50°49'.595N 001°12'.306W	Cog Sog 071°T 10.5kt	Heading 074°T	Speed 10.9kt
GOTO CURSOR 075°T 2.324nm 00h13m18s	Set Drift 304°T 0.9kt	Waypoint TTG 00h13m18s	VMG Wpt 10.5kt
		Depth 48.9ft	XTE 0.000nm
		Trip 73.48nm	Local Time 04:16:41 AM

Selecting the data application page

To use the data application, you need to select a page set that includes a data window.

For more information about page sets, see [Selecting a page set on page 26](#)

Preset data panels

The data application has 5 preset panels, each of which provides a particular category of data.

		Panel Type				
		Navigation	Waypoint	Route	Fishing	Sailing
Data content	Vessel position	✓	✓	✓	✓	
	Active waypoint	✓	✓	✓	✓	
	TTG	✓				
	VMG - Waypoint	✓				✓
	Depth	✓		✓	✓	
	Cog Sog	✓	✓	✓	✓	✓
	Heading	✓		✓	✓	✓
	Speed	✓			✓	✓
	Set/Drift	✓			✓	
	XTE	✓	✓	✓		
	Trip	✓				
	Local time	✓				
	Sea temperature				✓	
	Ground wind					✓
	App wind					✓
True wind					✓	
VMG wind					✓	

To select a preset data panel

1. Press the **ACTIVE** button.
2. Press the appropriate softkey.

11.3 Engine monitor

The engine monitor application provides data regarding your engine and associated resources.

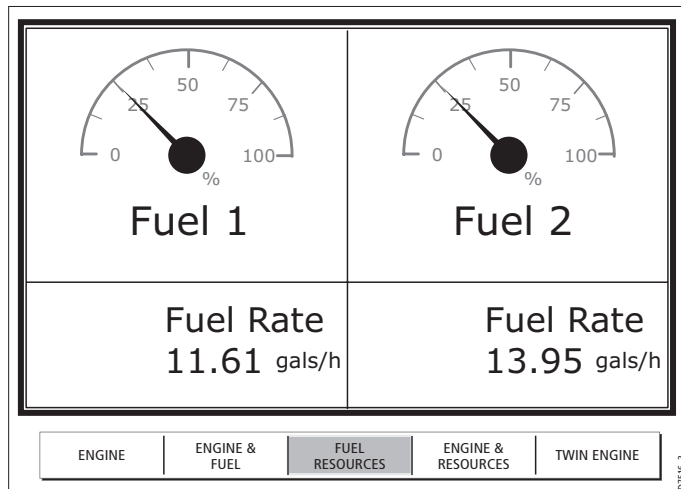

Setting up the engine monitor

Before you use the engine monitor, you need to:

- Customize a page set to include an engine monitor window.
- Set the number of engines and the maximum tachometer range to reflect your particular vessel.

For information about how to do customize page sets, see [Page sets on page 127](#).

To set engine and tachometer values

1. Press and hold the **PAGE/MENU** button and select **Panel Setup Menu**.
2. Set the number of engines.
3. Set the maximum tachometer range.

Preset engine monitor panels

The engine application has 5 preset panels, each of which provides a particular category of engine data.

		Panel Type				
		Engine	Engine & fuel	Fuel resources	Engine & resources	Twin engines
Data content	Tacho & engine hours	✓	✓		✓	✓
	Oil pressure	✓	✓			✓
	Engine coolant temperature	✓	✓			✓
	Boost pressure	✓	✓			
	Alternator	✓	✓			
	Fuel level (tanks 1 & 2)		✓	✓	✓	
	Fuel rate			✓	✓	
	Total fuel			✓	✓	

To select a preset engine monitor panel

1. Press the **ACTIVE** button.

2. Press the appropriate softkey.

Temperature and fuel units

Engine temperature units (°F or °C) and fuel units (liters, imperial gallons or US gallons) are defined in the System Setup Menu under Units Setup.

Engine monitor alarms

The engine monitor triggers an alarm (over NMEA/SeaTalk^{ng}) when a problem is detected.

If this occurs, check the engine monitoring system and if necessary refer to the documentation supplied with your engine system. Press **ACKNOWLEDGE** to silence the alarm.

Note: When engine monitoring is active, all other system alarms remain active.

11.4 Customizing data panels

You can customize each panel by changing any or all of the following attributes:

- Panel name.
- Size and number of data cells.
- Cell data: a cell can contain any transducer- or internally-calculated data that is available on NMEA or SeaTalk. Additional data includes a compass gauge, a distance log and four resettable trip counters.
- Type of display: data can be shown in numerical, gauge or graphical format as appropriate.

To rename a panel

1. Press and hold the **PAGE/MENU** button and select **Panel Setup Menu**.
2. Select the panel you want to rename.
3. Press the **RENAME** softkey.
4. Set the name.
5. Press **OK**.

To select data for a cell to contain

1. Press and hold the **PAGE/MENU** button and select **Panel Setup Menu**.
2. Select the cell you want to assign data to.
3. Press the **SELECT DATA** softkey.
4. Select the data type and format.
5. Press **OK**.

To split cells

1. Press and hold the **PAGE/MENU** button and select **Panel Setup Menu**.
2. Select the cell you want to split.
3. Press the vertical or horizontal **SPLIT CELL** softkey as appropriate.

The direction in which the selected cell will be split is indicated by an arrowhead on the softkey label.

To merge cells

1. Press and hold the **PAGE/MENU** button and select **Panel Setup Menu**.
2. From the pair of cells you want to merge, select either the left- or upper-most cell.
3. Press the vertical or horizontal **MERGE CELLS** softkey as appropriate.

The direction in which the cells will be merged is indicated by an arrowhead on the softkey label.

Chapter 12: System Setup and Customizing

12

This chapter details the settings available on the system Setup menu.

Chapter contents

- [12.1 Page sets on page 127](#)
- [12.2 Databar and Compass on page 127](#)
- [12.3 Compass Setup on page 128](#)
- [12.4 GPS status on page 128](#)
- [12.5 System-wide settings on page 130](#)

See also

For instructions on how to use the menus, see [Using the display on page 14](#).

12.1 Page sets

If none of the default page sets suit you, you can edit them to display the application and page layouts you want.

- Layout and split-screen arrangements
- Add or remove applications from the page sets

To configure a page set

1. Open the system **Setup** menu.
2. Open the **Select Page Set** screen.
3. Highlight the page set you want to edit.
4. Press the appropriate softkey:
EDIT PAGE SET
RENAME PAGE SET
RESET TO DEFAULT PAGES
5. Follow the on-screen instructions for the option you selected.
6. Press **OK**.

12.2 Databar and Compass

To configure the databar

1. Press and hold the **PAGE/MENU** button.
2. Select **Databar Setup**.
3. Select the required option.

4. Press **OK** when complete.

Databar option	Settings
Type and Position	Top Data Side Data Top Compass OFF
Top Databar Size	
Compass Bar Mode	
Configure	See configure options below.

Configure options

The configure options allow you to add or remove data from the databar.

Data groups	Data (abbreviations in brackets)
VESSEL	Vessel position (Ves Pos) Course over ground/Speed over ground (COG/SOG) Heading Speed Wind velocity made good (VMG Wind) Waypoint velocity made good (VMG Wpt) Log trip Log Trip Ground Log/Trip 1 Ground Log Ground Trip 1 Ground Trip 2 Ground Trip 3 Ground Trip 4 Rudder
NAVIGATION	Cross track error (XTE) Waypoint (WPT)
DEPTH	Depth
ENVIRONMENT	Pressure Air temperature (Air Temp) Sea temperature (Sea Temp) Set drift
WIND	True wind Apparent wind (App Wind) Ground wind

Data groups	Data (abbreviations in brackets)
TIME AND DATE	Local time Local date
CURSOR POSITION	Cursor position (Csr Pos)
TRANSDUCER STATUS	Transducer status

12.3 Compass Setup

This option can be used to linearize, or 'swing', a Raymarine ST80 active compass or Smart Heading sensor connected on SeaTalk.

Note: You calibrate an autopilot compass through the autopilot control head.

To linearize your compass

1. Select **Compass Setup**.
2. Press the **LINEARIZE COMPASS** softkey.
3. Follow the on-screen instructions.
4. Use the trackpad to fine-tune heading alignment.

12.4 GPS status

The GPS is used to position your boat on the chart. You can set up your Global Positioning System (GPS) and check its status from the GPS Status option in the Setup Menu.

For each tracked satellite, this screen provides:

- satellite number
- signal strength bar
- status
- azimuth angle
- elevation angle
- A sky-view to show the position of tracked satellites

To view GPS status

1. Press and hold the **PAGE/MENU** button.
2. Select **GPS Status**

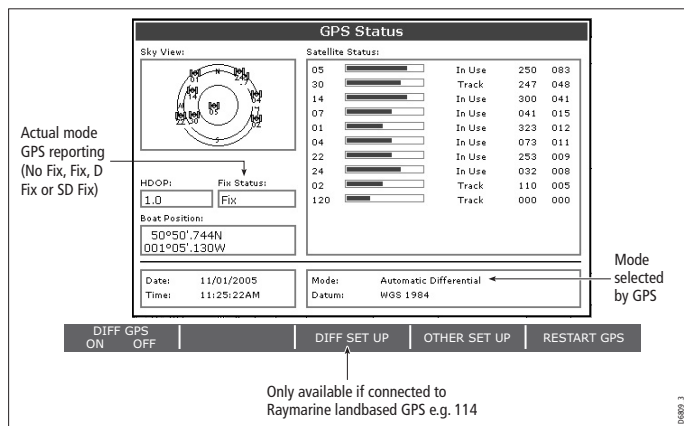

GPS accuracy depends upon the parameters shown, especially the azimuth and elevation angles which are used in triangulation to calculate your position.

Horizontal Dilution of Position (HDOP) is a measure of GPS accuracy; a higher figure signifies a greater positional error. In ideal

circumstances, the figure should be in the region of 1.0.

Satellite differential system

Select the satellite group(s) appropriate to your area using the Other Set Up softkey:

- WAAS - United States
- EGNOS - Europe
- MSAS - Japan
- GAGAN - India

Note: The EGNOS, MSAS and GAGAN systems may not be active. Check with your local government for operational status.

COG/SOG filter

Set the COG/SOG filter to the level appropriate to your use and to the level of oscillation being experienced by the GPS:

- **HIGH** for trawling or when there is a high level of oscillation.
- **MEDIUM** for general use.
- **LOW** when travelling at speed

12.5 System-wide settings

The following tables detail the options available under each of the system-wide menu items.

To access system settings

1. Press and hold the **PAGE/MENU** button.
2. Select the appropriate menu from those available

System Setup menu

MENU ITEM	OPTIONS
Position Mode Controls whether the position is expressed in latitude and longitude co-ordinates or Loran TDs.	Lat/Long TD's
TD Setup If the <i>Position Mode</i> is set to TD's, this function controls the selected chain identifier, slave and ASF.	Various
Simulator ON - allows operation of display without data from antenna and/or external data sources. Demo - a series of slides with descriptions to demonstrate the various system functions.	OFF ON Demo
Bearing Mode Mode of all bearing and heading data displayed. This does not affect how the chart is drawn.	True Magnetic

MENU ITEM	OPTIONS
MOB Data Type IMPORTANT: Dead reckoning mode is not recommended for use on A-Series displays. Dead reckoning will only provide the correct MOB position if the required COG, SOG and Tide data are available. Your boat and the MOB are subject to the same tide and wind effects, Assuming that the required data sources are available dead-reckoning can give a more accurate MOB position.	Dead Reckoning Position
Variation Source This allows you to compensate for the naturally occurring offset of the earth's magnetic field. When set to AUTO, the value the system would use (or is using) is noted in the menu e.g. 4 ⁰ W. To enter your own variation value, set to MANUAL.	Auto Manual
Manual variation If Variation Source is set to MANUAL then use this setting to enter the variation value. This value is transmitted to any other SeaTalk instruments.	0°E Range 0 - 30° east/west
Language Selected language used for screen text, labels, menus, options and display format for lat/lon position information.	Selection available will vary according to your location.
Extended Character Set Controls whether additional accented characters are made available when you are entering text.	OFF ON

MENU ITEM	OPTIONS
Ground Trip Reset... Resets the chosen ground trip distance counter to zero.	Ground Trip 1 - 4 Reset
Settings Reset Resets all system setup menus, including page sets and the data bar to the factory default. Waypoints, routes and tracks are NOT removed.	
Settings and Data Reset Resets all system setup menus, including page sets and the data bar to the factory default. Waypoints, routes and tracks are deleted.	
Date /Time Setup	See sub-menu below
Units Setup	See sub-menu below
System Integration	See sub-menu below
Waypoint Password Set-up... Allows you to set up a password to protect access to your waypoint and route databases.	

Date/Time Setup Menu

Date./time settings are a sub-menu from the system setup menu

MENU ITEM	OPTIONS
Date Format Displays date as day/month/year or month/day/year	mm/dd/yy dd/mm/yy

MENU ITEM	OPTIONS
Time Format Displays either 12 or 24 hour clock	12hr 24hr
Local Time Offset Specify local time in increments of 0.5 hours (+/- 13) from the Universal Time Constant. Use trackpad to individually adjust the value of the tens, units, and tenths - system rounds to nearest 0.5 hr.	+/- 13hrs from UTC

Units Setup Menu

Units setup is a sub-menu from the system setup menu

MENU ITEM	OPTIONS
Distance Unit Choose the units you require distances to be displayed in.	NM Miles km
Speed Units Choose the units that you require speed to be measured in.	Knots MPH KPH
Depth Units Choose the units that you require depths to be measured in.	Meters Feet Fathoms
Temperature Units Select required temperate unit.	Fahrenheit Celsius

MENU ITEM	OPTIONS
Pressure Units Select required pressure unit.	Bar Psi Kpa
Volume Units Select required volume unit.	US Gallons Imp Gallons Litres

System Integration Setup Menu.

System integration is a sub-menu from the system setup menu.

MENU ITEM	OPTIONS
DSC Message When set to ON, details of distress DSC messages are displayed on screen	ON OFF
SeaTalk Alarms When set to enabled, all SeaTalk system alarms are received and displayed on the chartplotter.	Enabled Disabled
Data Master When set to ON, the display you are working on is defined as the master.	ON OFF
Bridge NMEA Heading Used to prevent NMEA heading data being bridged onto the SeaTalk bus.	ON OFF

MENU ITEM	OPTIONS
NMEA Output Setup Allows you to switch off individual NMEA out sentences	APB, BWC, BWR, DBT, DPT, GGA, GLL, MTW, RMA, RMB, RMC, RSD, RTE, TTM, VHW, VLW, VTG, WPL, ZDA

NMEA Port Setting

Select the appropriate setting dependent on the equipment attached to the NMEA port for each individual display.

When Navtex 4,800 or 9,600 selected, the option to view the Navtex message list is available.

NMEA 4,800
Navtex 4,800
Navtex 9,600
AIS 38,400

Note: If AIS or Navtex has been set on any display in the system, the menu options will be available on all displays. Navtex and AIS are available simultaneously.

Alarm Setup Menu

The Alarm Setup Menu has five sub-menus:

- System Alarms Setup
- Navigation Alarms Setup
- Fishfinder Alarms Setup
- AIS Alarms Setup

To access alarm settings

1. Press and hold the **PAGE/MENU** button.
2. Select the **Alarm Setup** menu.

3. Select the appropriate alarms category from those available.

System Alarms Setup

System alarms sound in all applications.

MENU ITEM	OPTIONS
Anchor Alarm Switches the anchor alarm on or off.	OFF ON
Anchor Alarm Radius If the <i>Anchor Alarm</i> is set to ON, an alarm is triggered when you drift from your anchor position by more than the specified distance.	0.01 - 9.99 nm 0.10nm (or equivalent in the selected <i>Distance Unit</i>)
Timer Switches the countdown timer alarm on or off	OFF ON
Timer Period If the <i>Timer</i> is set to ON, the system counts down from the time you specify. An alarm is triggered when zero is reached.	00h01m - 99hrs 59mins 00h00m
Alarm Clock Switches the alarm clock on or off.	OFF ON
Alarm Clock Time If the <i>Alarm Clock</i> is set to ON, an alarm is triggered when the time you specify is reached.	00.01 - 24:00hrs 00:00

MENU ITEM

OPTIONS

Temperature Alarm If this alarm is set to ON, an alarm is triggered if the temperature moves into or out of the range that you have specified in <i>Lower Temperature Limit /Upper Temperature Limit</i> .	OFF ON
Lower Temperature Limit Specifies the lower limit of the sea temperature range that is to trigger the <i>Temperature Alarm</i> .	60°F 0°-99.8°F
Upper Temperature Limit Specifies the upper limit of the sea temperature range that is to trigger the <i>Temperature Alarm</i> .	75°F 0.2°-99.9°F

Navigation Alarms Setup

Navigation alarms will sound in any application when you are navigating

MENU ITEM

OPTIONS

Arrival Alarm Radius The distance from the target waypoint or the closest point of approach to the target waypoint that triggers the arrival alarm to sound.	0.1nm 0.01 - 9.99nm
---	------------------------

MENU ITEM	OPTIONS
Offtrack Alarm Switches the off-track alarm on or off	OFF ON
Offtrack Alarm XTE If the <i>Offtrack Alarm</i> is set to ON, an alarm is triggered when the XTE for any current navigation, exceeds the value that you have specified.	0.3nm 0.01 - 9.99nm (or equivalent in the selected <i>Distance Unit</i>)

Fishfinder Alarms Setup.

MENU ITEM	OPTION
Fish Alarm Switches the fish alarm on or off.	OFF ON
Fish Alarm Sensitivity If the <i>Fish Alarm</i> is set to ON, an alarm is triggered when the fish return strength reaches the sensitivity that you specify.	5% 10% - 100%
Fish Alarm Depth Limits If the <i>Fish Alarm</i> and this alarm is set to ON, an alarm is triggered (2 beeps) if any target meets the sensitivity level and is within the <i>Shallow Fish Limit</i> and <i>Deep Fish Limit</i> that you specify.	OFF ON
Shallow Fish Limit Specifies the lower value for the <i>Fish Alarm Depth Limit</i> .	2ft (0002ft - 1000ft)
Deep Fish Limit Specifies the upper value for the <i>Fish Alarm Depth Limit</i>	1000ft (0002ft - 5000ft)

MENU ITEM	OPTION
Shallow Depth Alarm Switches the shallow depth alarm on or off. If a DSM is not connected, this cannot be set.	OFF ON
Shallow Depth Alarm Value If the <i>Shallow Depth Alarm</i> is set to ON, an alarm is triggered if the depth drops below the value you specify.	5ft (0002ft - maximum range of transducer)
Deep Depth Alarm Switches the deep depth alarm on or off. If a DSM is not connected, this cannot be set.	OFF ON
Deep Depth Alarm Value If the <i>Deep Depth Alarm</i> is set to ON, an alarm is triggered if the depth exceeds the value that you specify.	

Note: If a fishfinder is not detected, the alarm setup windows are greyed out.

AIS Alarms Setup

Dangerous Targets Alarm OFF
Switches the alarm for dangerous targets to on or off. ON
When OFF, the AIS alarm off icon is displayed in the status bar.

AIS Alarm List
Details the identity, description, time and acknowledgement of alarm messages received from an AIS receiver.

Display setup

MENU OPTION	OPTIONS
Soft key Autohide Controls whether the toolbar is automatically hidden if not used for a period of 10 seconds. Pressing any key re-displays it.	OFF ON
Cursor Autohide Controls whether the cursor is automatically hidden if not used for 10 seconds. Pressing any key re-displays the cursor.	OFF ON
Key beep Controls whether a noise is made when you press a key.	OFF ON
Text size Controls the size of the text on the screen	Small Large

Chapter 13: Storing data and Chart / CF cards

13

CF (CompactFlash) cards expand the capabilities of your A-Series Multifunction Display. They provide the means to update cartography with Navionics chart cards, and also act as a storage device for routes, waypoints and other data.

Chapter contents

- [13.1 Card use and information on page 137](#)
- [13.2 Storing and retrieving data on page 139](#)
- [13.3 Sending and receiving data with a computer on page 140](#)
- [13.4 Password protection on page 140](#)

13.1 Card use and information

CAUTION: CompactFlash cards

When installing CompactFlash cards ensure that the card is fitted the correct way around. **DO NOT** try to force the card into position as this may result in irreparable damage to the card.

Removing the CompactFlash card while information is being written to or read from it may cause damage to the card and loss of all data.

DO NOT use a metallic instrument such as a screwdriver or pliers to remove a card, as doing this can cause irreparable damage.

CAUTION: Water ingress

To prevent the ingress of water and consequent damage to the display, ensure that the chart card door is firmly closed. This can be confirmed by an audible click.

- Archiving and updating
Enables the storing of waypoints, routes and tracks. Also enables the updating of system software.
- Saving data
Enables waypoints, route and track data to be saved for use on other equipment such as a personal computer.

Note: Raymarine recommends the use of SanDisk CF memory cards. Other brands of CF memory card may not work in your A-Series unit.

Using CompactFlash cards enables you to expand the capabilities of your A-Series System by providing:

- Enhanced or expanded cartographic information
The cards enable the user to obtain detailed cartographic information using Navionics chart cards. To check the current availability of Navionics chart card types, visit www.navionics.com or www.navionics.it
- The amount of cartographic detail available varies for different areas and different scales. The chart scale in use is indicated in the status bar - the number represents the distance in nautical miles from the top of the chart window to the bottom of the chart window.

Using the card slot

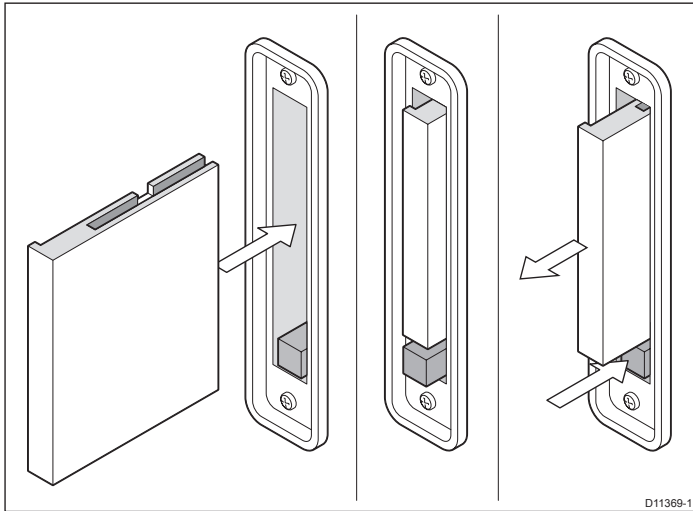

Inserting a CompactFlash card

Chart cards can be inserted and removed while a chart is displayed.

To insert a CompactFlash card:

1. Open the chart card door.
2. Insert the card with the lip of the card facing inwards (see above). It should position easily. If it does not, **DO NOT** force it but check the direction in which the lip is facing.
3. Gently press the card home.
4. To prevent the ingress of water and subsequent damage, close the chart card door and press firmly until it clicks.

Removing a CompactFlash card

Only remove the card while the CF Card Removal message is displayed.

Removing a card without accessing the setup menu may result in a system crash and/or loss of data.

To remove a CompactFlash card with the unit powered ON:

1. Press and hold the **PAGE/MENU** button to display the System Setup Menu.
2. Select **Remove CF Card**.
3. Remove the card when the dialog states it is safe to do so.
4. **DO NOT** remove the card unless told it is safe to do so as **this may result in loss of data**.
5. Open the chart card door.
6. Grip the card and firmly pull to remove it from the slot.
7. Close the chart card door until an audible click is heard. This will prevent water ingress.
8. Press **OK**.

To remove a CompactFlash card with the unit powered OFF:

1. Open the chart card door.
2. Grip the card and firmly pull to remove it from its slot.
3. Close the chart card door until an audible click is heard. This will prevent water ingress.

13.2 Storing and retrieving data

You can archive data to a CompactFlash card for safe-keeping or retrieval at a later date.

Alternatively, you can transfer data to another instrument or PC using NMEA. When navigation is active, you can also receive waypoints, routes and tracks from a PC, SeaTalk and NMEA instruments (see [page 140](#)).

Do not use your Navionics chart cards for storing and retrieving data, as doing so may delete or corrupt the cartography.

To save data to a CF card

1. Make sure the correct card is inserted.
2. Press and hold the **PAGE/MENU** button to display the System Setup Menu.
3. Select the **ARCHIVE AND TRANSFER** option.
4. Press the **SAVE TO CARD** softkey.
5. Select the data list you want to save on the **SELECT LIST** softkey.
6. Define the data you want to save by pressing the appropriate softkey.

To retrieve information from a CF card

1. Insert the appropriate card.
2. Press and hold the **PAGE/MENU** button to display the System Setup Menu.
3. Select the **ARCHIVE AND TRANSFER** option.
4. Press the **RETRIEVE FROM CARD** softkey.
5. Select the data list you want to retrieve from.

6. Define the data you want to retrieve by pressing the appropriate softkey.

If your selection is already found to exist on the system, a warning message appears and the softkey labels change to give you the options of retrieving as new, replacing the data or cancelling the retrieving process.

To erase information from a CF card

1. Insert the appropriate card.
2. Press and hold the **PAGE/MENU** button to display the System Setup Menu.
3. Select the **ARCHIVE AND TRANSFER** option.
4. Press the **ERASE FROM CARD** softkey.
5. Select the list you want to remove data from.
6. Define the data to be deleted.
7. Press **YES** to confirm

13.3 Sending and receiving data with a computer

You can transfer and retrieve waypoints or routes to and from another instrument or PC using NMEA.

With a RayTech 6.0's planner you can transfer waypoints and routes via a CF memory card. Such transfers require that the PC be connected to the display's NMEA port via a serial data cable.

To transfer or receive information from a computer

1. Press and hold the **PAGE/MENU** button to display the System Setup Menu.
2. Select the **ARCHIVE AND TRANSFER** option.
3. Press **TRANSFER ON NMEA**.
4. Press the softkey that corresponds to the transfer you want to perform.

To stop the transfer at any point, press **STOP TRANSFER**.

13.4 Password protection

If required, you can use password protection to control access to your waypoint and route databases. Once you have set up a password, it must be entered to access the Password Setup sub-menu, regardless of whether Password Protection is set to ON or OFF.

Password confirmation

When Password Protection is enabled and you attempt to access a password-protected function for the first time during a power-cycle, the system asks for the password for the following functions:

- Access WPTS key functions. This does not affect the operation of the MOB function.
- Access ROUTES soft key functions.
- Create a route from a track. All other track functions are unaffected.
- Archive or transfer any waypoints.
- Enter the Waypoint Password Setup menu.

Disabled data/functions

When Password Protection is ON and you have not entered a password you cannot:

- View details of waypoint and route databases.
- Edit waypoints or routes.
- Goto an existing waypoint.
- Follow a route.
- View waypoints on screen (even when the SHOW/HIDE status is set to SHOW).
- View waypoint names on screen (even when WAYPOINT NAME is set to ON).
- All other options including GOTO CURSOR are unaffected.

To set up a password

1. Open the system **Setup** menu.
2. Select **System Setup**.
3. Select **Waypoint Password Setup**.
4. Select **Enable Password: ON**.
5. Press **OK**.
6. Read and accept the warning.
7. Enter the password and confirm it.
8. If wanted, enter the password hint.

Note: The password is case sensitive.

The password is now set and protection enabled although access to the waypoint and route functions remains available until you restart your system.

To change the password

1. Select **Change Password** on the **Waypoint Password Setup** menu.

Enabling and disabling password protection

Once you have set up a password on your system (see previous section) you need to key in this password whenever you want to change the status of the password protection feature.

To enable or disable password protection

1. Open the system **Setup** menu.
2. Select **System Setup**.
3. Select **Waypoint Password Setup**.
4. Enter your password. Remember it is case-sensitive.
5. Select **Enable Password: OFF**.
6. Press **OK**.

If you enter an invalid password more than twice within one power cycle the system displays the password hint.

There is no limit to the number of attempts to enter a valid password but if you forget your password, you need to perform a Settings and Data Reset (see [page 144](#)) which will erase all waypoints in the unit's memory.

Chapter 14: Maintenance and troubleshooting

This chapter deals with maintenance and troubleshooting for the A-Series Multifunction Display, and covers the following:

Chapter contents

- [14.1 Safety on page 143](#)
- [14.2 Routine checks on page 143](#)
- [14.3 Resetting the system on page 144](#)
- [14.4 Troubleshooting on page 145](#)
- [14.5 Contacting Raymarine on page 147](#)
- [14.6 Contacting Navionics on page 148](#)
- [14.7 Contacting Sirius on page 149](#)

14.1 Safety



WARNING: High voltages

The display unit contains high voltages. DO NOT remove the display unit covers or attempt to service the equipment.



WARNING: Service and Maintenance

This product contains no user serviceable components. Please refer all maintenance and repair to authorized Raymarine dealers. Unauthorized repair may affect your warranty.

14.2 Routine checks

The A-Series Multifunction Display is a sealed unit. Maintenance is therefore limited to the following periodic checks:

- Examine all of the cables for signs of damage, such as chafing, cuts or nicks.
- Check that all cable connectors are firmly attached.

Cleaning

Cleaning the display case

The display unit is a sealed unit and does not require regular cleaning. If it necessary to clean the unit, follow these basic procedures:

- Ensure the power is set to OFF.
- Wipe the module using a damp cloth.
- If necessary, use isopropyl alcohol (IPA) or a mild detergent to remove grease marks.

Note: DO NOT use IPA or any other solvent / detergent on the screen.

Screen coating

A coating is applied to the plastic screen of your display. This makes it water repellent and prevents glare. To avoid damaging this coating, the recommended cleaning procedure must be followed.

Raymarine recommends Marine Shield screen cleaner for use with A-Series displays.

To clean the display screen:

1. Power OFF the display.
2. Rinse the window with fresh water to remove all particles of dirt and salt deposits.

3. Allow the window to dry naturally.
4. If any smears remain, very gently wipe the window with a clean microfiber cleaning cloth - available from an opticians.

When cleaning the display window DO NOT:

- *Use any abrasive materials, including a dry cloth.*
- *Do not use any cleaning solutions, polishes or sprays.*
- *Do not use a jet wash.*

Cleaning the transducer.

The paddle wheel mechanism may become jammed by dirt, grit or barnacles. Work the contaminant out of the mechanism, then clean the unit with soap and water or IPA.

14.3 Resetting the system

You can reset your A-Series display in one of two ways:

- Settings reset.
- Settings and data reset.

After applying either of the above resets, your system resets and returns you to the power-on procedure.

Settings reset

When you apply a settings reset, all system menus, page sets and the data bar are reset to the factory defaults. Waypoints, routes and tracks are not removed.

To apply a settings reset:

1. Open the *System Setup Menu*.
2. Select *System Setup*.
3. Select *Settings Reset*.
4. Press **OK** to confirm the reset.

Settings and data reset

When you apply a settings and data reset, all the system settings return to their default values and waypoint, route and tracks data is erased.

To apply a settings and data reset:

1. Open the *System Setup Menu*.
2. Select *System Setup*.
3. Select *Settings and Data Reset*.
4. Press **OK** to confirm the reset.

To apply a settings and data reset at power on:

1. Press and hold the left-most softkey whilst powering on the unit.

14.4 Troubleshooting

All Raymarine products are, prior to packing and shipping, subject to comprehensive test and quality assurance programs. However, if the unit develops a fault please refer to the following table to identify the most likely cause and the corrective action required to restore normal operation.

If there is still a problem after referring to the table, contact your local Raymarine dealer, national service agent or Raymarine Technical Services for further advice. Always quote the product serial number which can be found on the back of the unit.

This section is divided into problems associated with:

- Installation and display.
- Chart application.
- Fishfinder application.
- Weather receiver.

Installation and display

Problem

- Solution
-

System does not power ON

- Check power supply cable is undamaged and that all connections are tight and free from corrosion.
 - Check all relevant fuses.
 - Check power source is of the correct voltage and sufficient current.
-

System switches OFF

- Check power supply cable is undamaged and that all connections are tight and free from corrosion.
- Check the boat's power supply for faulty connections.
- Check any power cable extensions are the correct diameter

How do I reset the system?

- Refer to [Resetting the system on page 144](#).

Display very hard or dull to view

- Check the color palette is set to DAY.

No data bar shown

- Set the databar to ON in the Setup Menu.

No fix shown against the GPS icon

- Check GPS status.

No instrument or navigational data shown

- Check that the instrument interface is operating correctly.
- Check the SeaTalk/NMEA connection to the display unit.
- Check all SeaTalk/NMEA system cables are free from damage and corrosion.

Chart application

Problem

- Solution
-

Boat icon not shown in the correct geographical position

- Check GPS status.
- Check that the display unit is not in simulator mode.
- Perform the chart offset operation.

Chart does not show enough detail

- Set the Declutter option to OFF.
- In the Cartography Setup Menu, check that the appropriate features are set to ON.

Weather application

Problem

- Solution

'No connection'

- Check that the system cable for the weather receiver is securely connected and undamaged.

Weather data is not shown

- Check that the weather graphics are set to ON in the weather graphics menu.
-

14.5 Contacting Raymarine

Using the website

For the latest information on Raymarine products visit the website at www.raymarine.com.

Click on the region that you are located in and go to the **Customer Support** page for links to:

- Finding the location of the nearest factory service and authorized dealer for your area.
- Register Raymarine products.
- Accessing handbooks in Adobe Acrobat™ format.
- Downloading software updates.
- Accessing the Raymarine solution database.

Click **Find Answers** to use the searchable solution database, or click **Ask Raymarine** to submit a question to Raymarine technical support staff. A reply will be sent by e-mail.

In the US

Parts and accessories

Many Raymarine parts and accessories can be obtained from your local authorized Raymarine dealer.

However, if you are not able to obtain your requirements from the dealer, contact Raymarine Technical Services at:

1-603-881-5200 ext. 2333

Technical Service is available Monday through Friday 4.00AM to 6.00PM Eastern Time.

Please have the Raymarine item or part number ready when calling or placing an order. If you are not sure which item is appropriate for

your unit, you should contact the Technical Support Department to verify your requirements.

Technical Support

For technical support, call:

1-603-881-5200 ext 2444

Raymarine Technical Support Specialists are available to answer questions about installing, operating and troubleshooting all Raymarine products.

Product repair and service

In the unlikely event that your Raymarine unit should develop a problem, please contact your authorized Raymarine dealer for assistance. The dealer is best equipped to handle your service requirements and can offer timesaving help in getting the equipment back into normal operation.

In the event that repairs cannot be obtained locally, product service may also be obtained by returning the unit to:

Raymarine Inc.
Product Repair Center
21 Manchester Street
Merrimack, NH03054-44821

The Product Repair Center is open Monday through Friday 8.15 AM to 5.00 PM Eastern Time.

All products returned to the Repair Center are registered upon receipt. Should you wish to enquire about the repair status of the unit, contact the Product Repair Center at:

1-603-881-5200 ext 2118

Please have the unit serial number ready when you call. We will do everything possible to make the repair and return your unit as quickly as possible.

In Europe

In Europe, Raymarine support, service and accessories may be obtained from your authorized dealer or by contacting:

Raymarine plc
Anchorage Park
Portsmouth
Hampshire
England
PO3 5TD

Tel: +44 (0) 23 9269 3611
Fax: +44 (0) 23 9269 4642

Technical Support

Raymarine Technical Services Department handles enquiries concerning installation, operation, fault diagnosis and repair.

To contact the Technical Helpdesk:

Tel: +44 (0) 23 9271 4713
Fax: +44 (0) 23 9266 1228

Parts and accessories

Raymarine parts and accessory items are available through your authorized Raymarine dealer. Please refer to the lists of component part numbers and optional accessories in the Installation chapter of this handbook and have the numbers ready when speaking with your dealer.

If you are uncertain about what item to choose for your Raymarine unit, please contact the Customer Services Department prior to placing an order.

Worldwide

Please contact the authorized dealer in the relevant country as listed on the website at www.raymarine.com

14.6 Contacting Navionics

For questions about Navionics cartography, contact Navionics directly through their website at www.navionics.com, or contact Navionics Customer Support for your region as detailed below.

If you want to file a report of an error or omission on a Navionics chart, please provide the information to the Navionics website, Discrepancy Report section at <http://www.navionics.com/DiscrepancyReports.asp>.

Navionics Italy

Via Fondacci
269 Z.I. Montramito
55054 Massarosa
Italy

Tel: +39-0584-329111
Fax: +39-0584- 962696
e-mail: sales@navionics.it

Navionics US

6 Thatcher Lane
Wareham, MA02571
USA

Toll free: 1-800-848-5896
Tel: 1-508-291-6000
Fax: 1-508-291-6006
e-mail: sales@navionics.com

Navionics Australia

13/85 Reynolds Street

Balmain
NSW 2041
Australia

Tel: +61-2-9555-2522

Fax: +61-2-9555-2900

e-mail: sales@navionics.com.au

Navionics UK

PO Box 38
Plymouth
PL9 8YY
England

Tel: +44 (0)1752 204735

Fax: +44 (0) 1752 204736

e-mail: sales@navionics.co.uk

14.7 Contacting Sirius

For questions about the Sirius Marine Weather Service, contact:

www.sirius.com/marineweather

Tel: 1-800-869-5480

Appendix A: Disclaimers and licenses



ACKNOWLEDGMENTS

Navionics HotMaps is produced using the best available source data derived from pro-staffers, Navionics surveys, and leading private and public sources that may include: FHS - Fishing Hot Spots, LakeMaster (Big Watab Lake, Cedar, Geneva, Ida, North Long Lake, North Round Lake, Sugar), Lakewatch, DNR - Departments of Natural Resources, NOAA - National Oceanic Atmospheric Administration, USACE - United States Army Corps of Engineers, NHS - Natural History Survey, USGS - United States Geological Surveys, OKDWC - OK Dept. of Wildlife Conservation, VADGIF - VA Dept. of Game & Inland Fisheries, NDG&FD - ND Game & Fish Dept., MADFW - MA Div. of Fisheries & Wildlife Districts (Western, Central, Connecticut Valley, Northeast, Southeast), KSGS - KS Geological Survey, INGS - Indiana Geological Survey, CTDEP - Connecticut Dept. of Environmental Protection, and the Geography Division - Statistics Canada, 2006 Road Network File (RNF), 92-500 XWE/XWF. The incorporation of data sources within this product shall not be construed as constituting an endorsement of such product.



Navionics Coastal Charts are derived, in part, from the products and with the agreement of the hydrographic offices of Australia, Denmark (KMS), Finland (FMA), France (SHOM), Germany (BSH), Greece, Italy, Norway, South Africa, Sweden (SMA), Ukraine (SHSU), United Kingdom, and ANWB (The Netherlands), DPI WA (Australia), GBRMPA (Australia), Imray (UK), MSQ (Australia), NLS (Finland). These companies and hydrographic offices have not verified the product and do not accept liability for its accuracy. For further copyright information please see: www.navionics.com.

©1985-2008 Navionics. All rights reserved.

INS/RM/AS/0808

NAVIONICS CHART DATA END USER LICENSE AGREEMENT

IMPORTANT NOTES: READ THIS AGREEMENT BEFORE USING THE ELECTRONIC CHARTS PRELOADED IN YOUR RAYMARINE® DEVICE (THE "PRODUCT").

THE CHART DATA IS MERELY AN AID TO NAVIGATION DESIGNED TO FACILITATE THE USE OF AUTHORIZED GOVERNMENT CHARTS, NOT TO REPLACE THEM. ONLY OFFICIAL GOVERNMENT CHARTS AND NOTICES TO MARINERS CONTAIN ALL THE INFORMATION NEEDED FOR SAFE NAVIGATION, AND AS ALWAYS, THE CAPTAIN IS RESPONSIBLE FOR THEIR PRUDENT USE. IT IS THE ULTIMATE RESPONSIBILITY OF THE USER TO EXERCISE DISCRETION AND PROPER NAVIGATIONAL SKILL INDEPENDENT OF ANY DATA OR DEVICE.

NAVIONICS CHARTS MAKE USE OF A COMBINATION OF GOVERNMENTAL, PRIVATE AND NAVIONICS PROPRIETARY SOURCES AND ARE NOT OFFICIAL GOVERNMENTAL CHARTS AND MAY NOT CONTAIN THE LATEST UPDATE OF THE INFORMATION CONTAINED THEREIN. LIKE VIRTUALLY ALL DATA SOURCES, THE SOURCES ON WHICH NAVIONICS CHARTS ARE BASED MAY CONTAIN INACCURACIES. THEREFORE NAVIONICS CHARTS MAY BE USED FOR GENERAL DIRECTIONAL INFORMATION BUT SHOULD NOT BE RELIED UPON FOR PERSONAL SAFETY OR FOR ANY PURPOSE REQUIRING PRECISE MEASUREMENT OF DIRECTION, DISTANCE, LOCATION OR TOPOGRAPHY. USE OF THIS CHART DATA IS AT THE USER'S RISK: IT IS THE USER'S RESPONSIBILITY TO USE THIS PRODUCT PRUDENTLY.

NAVIONICS MAY FROM TIME TO TIME LABEL CHART DATA OBSOLETE BECAUSE THE NAVIGATIONAL CHARTS USED IN THE CHART DATA WERE UPDATED BY THE NATIONAL HYDROGRAPHIC OFFICES, OR FOR OTHER REASONS. IF THE CHART DATA IS LABELED AS OBSOLETE YOU SHOULD NOT USE THE CHART DATA AS AN AID TO

NAVIGATION AND YOU SHOULD PURCHASE AN UPGRADED VERSION OF THE CARTOGRAPHY DATA INFORMATION FOR THE RELEVANT GEOGRAPHIC AREA. IT IS YOUR RESPONSIBILITY TO DETERMINE WHETHER CHART DATA IN THE PRODUCT HAVE BEEN LABELED OBSOLETE BY CHECKING WWW.NAVIONICS.COM OR CONTACTING NAVIONICS AT INFO@NAVIONICS.COM

This is a legal Agreement between NAVIONICS S.P.A. ("NAVIONICS"), YOU and RAYMARINE plc ("RAYMARINE"). By using the electronic charts that are preloaded in the Product, you are consenting to the terms of this Agreement. If you do not agree to the terms of this Agreement, Navionics is unwilling to license the Electronic Charts to you and you must not use the Product. In these circumstances please return the Product on which the Electronic Charts are stored together with all accompanying documentation and proof of purchase, to the retailer where you purchased it within 28 days of purchase. If you do this, the price paid for the Product will be refunded. If you bought the Product from an authorized third party retailer, please note that the retailer has the right to enter into this license on our behalf.

DEFINITIONS: As used in this Agreement,

"Chart Data" or "Electronic Charts" means the cartography data information produced and licensed hereunder by Navionics and preloaded in the hard drive of the Product.

"Date of first purchase" means the date on which the Product was purchased by the First retail purchaser or in the case of the purchase of a vessel from a Raymarine certified original equipment manufacturer on which a new Product is installed, the date of such purchase.

"First retail purchaser" means the first retail customer who purchased the Product or, where the Product was installed and/or commissioned on a vessel by a Raymarine certified original equipment manufacturer, the first retail customer who purchased the vessel on which the Product is installed. For a Product installed by a Raymarine certified installer on a vessel already

in the customer's possession, the First retail purchaser shall mean the customer in possession of the vessel at the time of Product installation.

"Related Materials" means all of the printed materials and whatever is in the Product package related to the Chart Data.

"Warranty period" shall mean a period starting on the date of first purchase and ending on the first anniversary of the date of first purchase, or the date on which Navionics labels the Chart Data obsolete, whichever occurs first.

It is AGREED as follows:

You acknowledge that the Chart Data has not been developed to meet your individual requirements and that it is therefore your responsibility to ensure that the facilities and functions of the Chart Data (as described in the documentation that accompanies the Product) meet your requirements.

USES PERMITTED BY NAVIONICS: This Agreement gives you certain limited rights to use and maintain the Chart Data solely with the Product. Chart Data may be used on the Product as an electronic chart/map and as an aid to navigation. You agree to use reasonable efforts to protect the Chart Data from unauthorized use, reproduction, distribution or publication. Navionics reserves all rights to the Chart Data not specifically granted in this Agreement.

USES NOT PERMITTED BY NAVIONICS: YOU MAY NOT (1) make copies of the Chart Data; (2) alter, recompile, disassemble or reverse-engineer the Chart Data, or make any attempt to unlock or bypass the initialization system or encryption techniques utilized; (3) remove or obscure the Navionics copyright and trademark notices.

Navionics explicitly reserves the right to enforce any legal rights arising from your failure to comply with any provision of this Agreement.

LIMITED WARRANTY: You purchased the Chart Data and Related Materials together with, or pre-loaded on, the Product. Navionics warrants that during the Warranty period (i) Navionics has the right to grant you the rights to use the Chart Data and Related Materials as provided by this Agreement; and (ii) the Chart Data substantially represents the navigational charts issued by the national hydrographic offices for the geographic area covered. Navionics does not warrant that the Chart Data will be error-free or bug-free or will operate without interruption during the Warranty period.

WARRANTY EXCLUSIONS This limited warranty does not cover nonconforming Chart Data or Related Materials due to obsolescence, abuse, non-authorized equipment modification, alteration or misuse.

Your exclusive remedy as to Chart Data or Related Materials that fail to conform to the limited warranty above shall be as follows:

(a) you must promptly submit the Product to Raymarine (for details, please refer to www.raymarine.com) for inspection, together with a dated proof of purchase of the Product and a written notice describing the alleged failure of the Chart Data or the Related Materials to conform to the limited warranty in sufficient detail to enable such failure to be analyzed and reproduced;

(b) if it is possible to reproduce the alleged failure and determine that the Chart Data or the Related Materials do not conform to the limited warranty, Navionics will (at its sole option) repair or replace the nonconforming Chart Data or Related Materials. Navionics shall complete the repairs or replacement by issuing a file to Raymarine, in a card or Internet downloadable format, at Navionics' option. In the event Navionics determines in its sole discretion that it is not able to repair or replace the nonconforming Chart Data or Related Materials that is preloaded into a Product, then, in such case, Navionics will issue a chart for replacement on Compact Flash (CF) card. Raymarine will install such replacement on your Product as agent for Navionics.

For the avoidance of doubt, as licensee of the Chart Data and Related Materials, Raymarine does not warrant the Chart Data or Related Materials,

and has no liability or responsibility to repair or replace the Chart Data or the Related Materials. Raymarine merely facilitates the diagnosis of whether any preloaded Chart Data or Related Materials fail to conform to the limited warranty provided by Navionics hereunder and installs any replacements provided by Navionics for such purpose as agent for Navionics.

This limited warranty gives you specific legal rights; you may have others, which vary from jurisdiction to jurisdiction.

For purposes of this Agreement and the limited warranty, "Chart Data" shall NOT include (and the terms and conditions of this Agreement shall NOT apply to) any upgrades, updates or modified versions of Chart Data unless expressly provided as a warranted repair or replacement above, and then in such case any repair or replacement of the Chart Data as provided herein will benefit from the Navionics limited warranty described above for a period of 12 months from the date of repair/replacement.

DISCLAIMER: EXCEPT FOR THE LIMITED WARRANTIES DESCRIBED ABOVE, THE DATA AND THE RELATED MATERIALS ARE LICENSED "AS IS". NAVIONICS DISCLAIMS ANY AND ALL OTHER WARRANTIES, WHETHER EXPRESS OR IMPLIED, INCLUDING, WITHOUT LIMITATION, ANY IMPLIED WARRANTIES OF MERCHANTABILITY, FITNESS FOR A PARTICULAR PURPOSE OR NON-INFRINGEMENT. YOU ASSUME THE ENTIRE RISK AS TO PERFORMANCE AND RESULTS OF THE CHART DATA.

CUMULATIVE LIABILITY FOR EITHER NAVIONICS OR RAYMARINE (OR ANY NAVIONICS OR RAYMARINE AFFILIATE OR SUBSIDIARY) TO YOU OR ANY OTHER PARTY FOR ANY LOSS OR DAMAGES RESULTING FROM ANY CLAIMS, DEMANDS, OR ACTIONS ARISING OUT OF OR RELATING TO THIS AGREEMENT SHALL NOT EXCEED, (I) THE PREVAILING LIST PRICE FOR THAT PRODUCT; OR (II) \$1000, WHICHEVER IS MORE. IN NO EVENT SHALL NAVIONICS OR RAYMARINE BE LIABLE FOR ANY INDIRECT, INCIDENTAL, CONSEQUENTIAL, SPECIAL, OR EXEMPLARY DAMAGES OR LOST PROFITS, EVEN IF NAVIONICS OR RAYMARINE HAS BEEN ADVISED OF THE POSSIBILITY OF SUCH DAMAGES.

Notwithstanding any wording to the contrary, nothing in this Agreement shall exclude or in any way limit Navionics' or Raymarine's liability for fraud, or for death and personal injury caused by its negligence, or any other liability to the extent the same may not be excluded or limited as a matter of law.

If any of the terms of this Agreement are determined by any competent authority to be invalid, unlawful or unenforceable to any extent, such term, condition or provision will to that extent be severed from the remaining terms, conditions and provisions which will continue to be valid to the fullest extent permitted by law.

ACKNOWLEDGMENT: You acknowledge that you have read this limited warranty provision regarding the Chart Data and the Related Materials, understand it, and agree to be bound by its terms and conditions. You also agree that: (1) no oral or written information or advice given by Navionics or Raymarine, their dealers, distributors, agents or employees shall in any way increase the scope of this warranty, and you may not rely on any such information or advice; and (2) this warranty provision is the complete and exclusive statement of agreement regarding warranty of the Chart Data and the Related Materials by Navionics and Raymarine and supersedes all proposals or prior agreements, oral or written, and any other communications you may have had prior to purchasing.

Sirius weather

ADVISORY NATURE OF SERVICE; SUBSCRIBERS RESPONSIBILITY
Subscriber ('Subscriber') acknowledges and agrees that the data service ('the Service') is advisory in nature and all actions and judgements taken with respect to the Service are Subscriber's sole responsibility. Neither WSI Corporation ('WSI') nor Sirius Satellite Radio Inc. ('Sirius') makes any representations or warranties with respect to the reliability, predictive value or accuracy of the information contained within the Service, and neither WSI nor Sirius shall be responsible for inaccurate, omitted, delayed or erroneous information. Subscriber further acknowledges and agrees that the Service may be interrupted due to adverse weather or other conditions and that neither WSI or Sirius shall have any liability for such interruptions. Subscriber is urged to verify the contents of the Service against other sources prior to use. Subscriber acknowledges and agrees that under no circumstances should the user of this Service make decisions based solely or primarily on weather information contained within the Service. In addition, it is Subscriber's responsibility to exercise discretion and observe all safety measures required by law and his or her own common sense. Neither WSI or Sirius assumes any responsibility for accidents resulting from or associated with use and/or misuse of the service.

ELIGIBILITY; USE LIMITATIONS

Subscriber must be at least 18 years old to assume the obligations set forth in these terms. Minors may use the Service only if a parent or legal guardian assumes the obligations set forth in these Terms and thereby assumes full responsibility for the minor's use of the Service. Sirius provides the Service only for your personal, non-commercial enjoyment. Subscriber may not make commercial use of, reproduce, rebroadcast, redistribute or otherwise transmit the Service, or record, charge admission for utilizing or distribute information from the Service.

LIMITATION OF LIABILITY; INDEMNIFICATION; WARRANTY DISCLAIMER

A. NOTWITHSTANDING ANYTHING CONTAINED HEREIN, OR THE FORUM IN WHICH ANY LEGAL OR EQUITABLE ACTION MAY BE BROUGHT BY SUBSCRIBER AGAINST WSI AND/OR SIRIUS, SUBSCRIBER AGREES THAT EACH OF WSI'S AND SIRIUS LIABILITY, IF ANY, TO THE SUBSCRIBER FOR ANY LOSS, DAMAGE, CLAIM, LIABILITY OR EXPENSE, OF ANY KIND CAUSED DIRECTLY

OR INDIRECTLY BY THE PERFORMANCE OR NONPERFORMANCE OF OBLIGATIONS PURSUANT TO THIS AGREEMENT OR BY THE NEGLIGENCE, ACTIVE OR PASSIVE, OF WSI AND/OR SIRIUS SHALL BE EXCLUSIVELY LIMITED TO GENERAL MONEY DAMAGES IN AN AMOUNT NOT TO EXCEED THE PRICE PAID BY THE SUBSCRIBER TO SIRIUS HEREUNDER FOR THE MOST RECENT SIX MONTHS OF SERVICE. IN NO EVENT SHALL WSI AND/OR SIRIUS BE LIABLE FOR SPECIAL, INDIRECT, INCIDENTAL, CONSEQUENTIAL, EXEMPLARY OR PUNITIVE DAMAGES OR LOST PROFITS OR DAMAGES FROM LOSS OF USE OR DATA (DESPITE THE FACT THAT THE POSSIBILITY OF SUCH DAMAGES ARE OR MAY BE KNOWN TO WSI AND/OR SIRIUS), WHETHER ARISING OUT OF BREACH OF AGREEMENT, TORT OR ANY OTHER CAUSE OF ACTION RELATING TO THE PERFORMANCE OR NON-PERFORMANCE OF THIS AGREEMENT. THIS ALLOCATION OF RISK AND THE DISCLAIMER OF WARRANTIES IN THIS AGREEMENT ARE REFLECTED IN SIRIUS SERVICE PRICES AND ARE A FUNDAMENTAL ELEMENT OF SIRIUS AGREEMENT TO PROVIDE THE SERVICE TO SUBSCRIBER. SUBSCRIBER MAY HAVE GREATER RIGHT THAN DESCRIBED UNDER HIS OR HER STATE'S LAW.

B. EXCEPT FOR WILLFUL MISCONDUCT ON THE PART OF WSI AND/OR SIRIUS, SUBSCRIBER SHALL DEFEND, INDEMNIFY AND HOLD HARMLESS WSI AND SIRIUS FROM AND AGAINST ANY AND ALL LOSSES, CLAIMS, DEMANDS, EXPENSES (INCLUDING REASONABLE ATTORNEY'S FEES AND EXPENSES) OR LIABILITIES OF WHATEVER NATURE OR KIND ASSERTED BY, SUFFERED OR INCURRED BY THIRD PARTIES ARISING OUT OF THE USE OF THE SERVICE.

C. NEITHER WSI NOR SIRIUS MAKES ANY WARRANTY WITH RESPECT TO THE SERVICE AND, THE SERVICE IS PROVIDED ON AN 'AS IS' AND AN 'AS AVAILABLE' BASIS. NEITHER WSI NOR SIRIUS MAKES ANY EXPRESS OR IMPLIED REPRESENTATIONS OR WARRANTIES OF ANY KIND, INCLUDING BUT NOT LIMITED TO, WARRANTIES OF FITNESS FOR A PARTICULAR PURPOSE, INTENDED USE OR MERCHANTABILITY (WHICH ARE ALL HEREBY DISCLAIMED). NEITHER WSI NOR SIRIUS ASSUMES ANY RESPONSIBILITY WITH RESPECT TO THE USE OF THE SERVICE BY A PARTY.

Raymarine®
...world leaders in marine electronics.

www.raymarine.com

